

MP1632C
Digital Data Analyzer
Operation Manual

Sixth Edition

**For safety and warning information, please read this manual before attempting to use the equipment.
Keep this manual with the equipment.**

ANRITSU CORPORATION

Safety Symbols

To prevent the risk of personal injury or loss related to equipment malfunction, Anritsu Corporation uses the following safety symbols to indicate safety-related information. Ensure that you clearly understand the meanings of the symbols BEFORE using the equipment. Some or all of the following symbols may be used on all Anritsu equipment. In addition, there may be other labels attached to products that are not shown in the diagrams in this manual.

Symbols used in manual

DANGER  This indicates a very dangerous procedure that could result in serious injury or death if not performed properly.

WARNING  This indicates a hazardous procedure that could result in serious injury or death if not performed properly.

CAUTION  This indicates a hazardous procedure or danger that could result in light-to-severe injury, or loss related to equipment malfunction, if proper precautions are not taken.

Safety Symbols Used on Equipment and in Manual

The following safety symbols are used inside or on the equipment near operation locations to provide information about safety items and operation precautions. Ensure that you clearly understand the meanings of the symbols and take the necessary precautions BEFORE using the equipment.



This indicates a prohibited operation. The prohibited operation is indicated symbolically in or near the barred circle.



This indicates an obligatory safety precaution. The obligatory operation is indicated symbolically in or near the circle.



This indicates a warning or caution. The contents are indicated symbolically in or near the triangle.



This indicates a note. The contents are described in the box.



These indicate that the marked part should be recycled.

MP1632C
Digital Data Analyzer
Operation Manual

1 April 2001 (First Edition)
8 September 2006 (Sixth Edition)

Copyright © 2001-2006, ANRITSU CORPORATION.

All rights reserved. No part of this manual may be reproduced without the prior written permission of the publisher.

The contents of this manual may be changed without prior notice.

Printed in Japan

For Safety

WARNING



1. ALWAYS refer to the operation manual when working near locations at which the alert mark shown on the left is attached. If the advice in the operation manual is not followed there is a risk of personal injury or reduced equipment performance. The alert mark shown on the left may also be used with other marks and descriptions to indicate other dangers.

2. IEC 61010 Standard

The IEC 61010 standard specifies four categories to ensure that an instrument is used only at locations where it is safe to make measurements. This instrument is designed for measurement category I (CAT I). DO NOT use this instrument at locations specified as category II, III, or IV as defined below.

Measurement category I (CAT I):

Secondary circuits of a device that is not directly connected to a power outlet.

Measurement category II (CAT II):

Primary circuits of a device that is directly connected to a power outlet, e.g., portable tools or home appliance.

Measurement category III (CAT III):

Primary circuits of a device (fixed equipment) to which power is supplied directly from the distribution panel, and circuits running from the distribution panel to power outlet.

Measurement category IV (CAT IV):

Building service-line entrance circuits, and circuits running from the service-line entrance to the meter or primary circuit breaker (distribution panel).



3. To ensure that the instrument is grounded, always use the supplied 3-pin power cord, and insert the plug into an outlet with a ground terminal. If power is supplied without grounding the equipment, there is a risk of receiving a severe or fatal electric shock.

For Safety

WARNING

Repair

WARNING 

Calibration



Falling Over

LCD

4. This equipment cannot be repaired by the operator. DO NOT attempt to remove the equipment covers or unit covers or to disassemble internal components. Only qualified service personnel with a knowledge of electrical fire and shock hazards should service this equipment. There are high-voltage parts in this equipment presenting a risk of severe injury or fatal electric shock to untrained personnel. In addition, there is a risk of damage to precision components.
5. The performance-guarantee seal verifies the integrity of the equipment. To ensure the continued integrity of the equipment, only Anritsu service personnel, or service personnel of an Anritsu sales representative, should break this seal to repair or calibrate the equipment. If the performance-guarantee seal is broken by you or a third party, the performance of the equipment cannot be guaranteed.
6. This equipment should always be positioned in the correct manner. If the cabinet is turned on its side, etc., it will be unstable and may be damaged if it falls over as a result of receiving a slight mechanical shock.
Always set up the equipment in a position where the power switch can be reached without difficulty.
7. This instrument uses a Liquid Crystal Display (LCD). DO NOT subject the instrument to excessive force or drop it. If the LCD is subjected to strong mechanical shock, it may break and liquid may leak.
This liquid is very caustic and poisonous.
DO NOT touch it, ingest it, or get in your eyes. If it is ingested accidentally, spit it out immediately, rinse your mouth with water and seek medical help. If it enters your eyes accidentally, do not rub your eyes, rinse them with clean running water and seek medical help. If the liquid gets on your skin or clothes, wash it off carefully and thoroughly.

For Safety

CAUTION

Fuse Replacement

CAUTION 

1. Always remove the mains power cable from the power outlet before replacing blown fuses. There is a risk of electric shock if fuses are replaced with the power cable connected. Always use new fuses of the type and rating specified on the rear panel of the instrument. There is a risk of fire if a fuse of a different rating is used.

F8A indicates a time-lag fuse.

Cleaning

2. Keep the power supply and cooling fan free of dust.
 - Clean the power inlet regularly. If dust accumulates around the power pins, there is a risk of fire.
 - Keep the cooling fan clean so that the ventilation holes are not obstructed. If the ventilation is obstructed, the cabinet may overheat and catch fire.
3. Use two or more people to lift and move this equipment, or use a trolley. There is a risk of back injury, if this equipment is lifted by one person.

 CAUTION/注意

>18kg

HEAVY WEIGHT/重量物

For Safety

CAUTION

Replacing Memory Back-up Battery

This equipment uses a Poly-carbomonofluoride lithium battery to backup the memory. This battery must be replaced by service personnel when it has reached the end of its useful life; contact the Anritsu sales section or your nearest representative.

Note: The battery used in this equipment has a maximum useful life of 7 years. It should be replaced before this period has elapsed.

External Storage Media

This equipment uses HDD and FDD as external storage media for storing data and programs.

If this media is mishandled or becomes faulty, important data may be lost. To prevent this chance occurrence, all important data and programs should be backed-up.

Anritsu will not be held responsible for lost data.

Pay careful attention to the following points.

- Never turn off the power, while the HDD is being accessed.
- Never add the equipment vibration or shock to avoid crush in the HDD.
- Never remove the FD from the FDD, while it is being accessed.

Floppy Disk

Do not place in a dusty area.

Clean the magnetic head periodically to ensure normal operation.

Refer to the section on cleaning the head later in this manual.

Equipment Certificate

Anritsu Corporation certifies that this equipment was tested before shipment using calibrated measuring instruments with direct traceability to public testing organizations recognized by national research laboratories, including the National Institute of Advanced Industrial Science and Technology, and the National Institute of Information and Communications Technology, and was found to meet the published specifications.

Anritsu Warranty

Anritsu Corporation will repair this equipment free-of-charge if a malfunction occurs within one year after shipment due to a manufacturing fault, under the condition that this warranty is void when:

- The fault is outside the scope of the warranty conditions described in the operation manual.
- The fault is due to mishandling, misuse, or unauthorized modification or repair of the equipment by the customer.
- The fault is due to severe usage clearly exceeding normal usage.
- The fault is due to improper or insufficient maintenance by the customer.
- The fault is due to natural disaster including fire, flooding, earthquake, etc.
- The fault is due to use of non-specified peripheral equipment, peripheral parts, consumables, etc.
- The fault is due to use of a non-specified power supply or in a non-specified installation location.

In addition, this warranty is valid only for the original equipment purchaser. It is not transferable if the equipment is resold.

Anritsu Corporation will not accept liability for equipment faults due to unforeseen and unusual circumstances, nor for faults due to mishandling by the customer.

Anritsu Corporation Contact

In the event that this equipment malfunctions, contact an Anritsu Service and Sales office. Contact information can be found on the last page of the printed version of this manual, and is available in a separate file on the CD version.

Notes On Export Management

This product and its manuals may require an Export License/Approval by the Government of the product's country of origin for re-export from your country.

Before re-exporting the product or manuals, please contact us to confirm whether they are export-controlled items or not.

When you dispose of export-controlled items, the products/manuals need to be broken/shredded so as not to be unlawfully used for military purpose.

Crossed-out Wheeled Bin Symbol

Equipment marked with the Crossed-out Wheeled Bin Symbol complies with council directive 2002/96/EC (the “WEEE Directive”) in European Union.



For Products placed on the EU market after August 13, 2005, please contact your local Anritsu representative at the end of the product's useful life to arrange disposal in accordance with your initial contract and the local law.

Software License Agreement

Please read this Software License Agreement before using the accompanying software program (hereafter this software).

You are authorized to use this software only if you agree to all the terms of this License.

By opening the sealed package containing this software, you are agreeing to be bound by the terms of this license.

If you do not agree to these terms, return the unopened software package to Anritsu Corporation (hereafter Anritsu).

1. License

- (1) This license gives you the right to use this software on one MP1632C. (hereafter computer system).
- (2) To use this software on one computer system, this license allows you to make one copy of this software on the storage device of your computer system.
- (3) You must obtain a site license to use this software on more than one computer system even if such computer systems are not operating simultaneously.

2. Copyright

- (1) Although you are licensed to use this software, Anritsu retains the copyright.
- (2) Although you have purchased this software, rights other than those specified in this license are not transferred to you.
- (3) You may not print, copy, modify, create derivative works, incorporate in other software programs, decompile or disassemble this software in whole or in part, without obtaining prior written permission from Anritsu.

3. Copying

Notwithstanding item (3) of section 2 above, you may make one copy of this software for backup purposes only. In this case, you may only use either the original or the backup copy of this software.

4. Termination

- (1) Anritsu will deem this license to be automatically terminated if you fail to comply with any provision of this license. Upon termination, you will lose all rights to this software.
- (2) Either party (Anritsu or Licensee) to this Software License Agreement may terminate this agreement by giving written notice, at least one month in advance, to the other party.
- (3) Upon termination of this license for any reason, you must either immediately destroy this software and related documentation, or return it to Anritsu.

END-USER LICENSE AGREEMENT FOR MICROSOFT SOFTWARE

IMPORTANT-READ CAREFULLY: This End-User License Agreement ("EULA") is a legal agreement between you (either an individual or a single entity) and the manufacture("Manufacturer") of the special purpose computing device("SYSTEM") you acquired which includes certain Microsoft software product(s) installed on the SYSTEM ("SOFTWARE"). The SOFTWARE includes computer software, the associated media, any printed materials, and any "online" or electronic documentation. By installing, copying, or otherwise using the SOFTWARE, you agree to be bound by the terms of this EULA. If you do not agree to the terms of this EULA, Manufacturer and Microsoft Corporation ("Microsoft") are unwilling to license the SOFTWARE to you. In such event, you may not use or copy the SOFTWARE, and you should promptly contact Manufacturer for instructions on return of the unused product(s) for a refund.

SOFTWARE LICENSE

The SOFTWARE is protected by copyright laws and international copyright treaties, as well as other intellectual property laws and treaties. The SOFTWARE is licensed, not sold.

1. GRANT OF LICENSE. This EULA grants you the following rights:

- **Software.** You may use the SOFTWARE as installed on the SYSTEM.
- **Back-up Copy.** If MANUFACTURER has not included a copy of the SOFTWARE on separate media with the SYSTEM, you may make a single copy of the SOFTWARE for use solely for archival purposes with the SYSTEM.

2. DESCRIPTION OF OTHER RIGHTS AND LIMITATIONS.

- **Limitations on Reverse Engineering, Decompilation, and Disassembly.** You may not reverse engineer, decompile, or disassemble the SOFTWARE, except and only to the extent that such activity is expressly permitted by applicable law notwithstanding this limitation.
- **Single SYSTEM.** The SOFTWARE is licensed with the SYSTEM as a single integrated product. The SOFTWARE may only be used with the SYSTEM.
- **Rental.** You may not rent or lease the SOFTWARE.
- **Software Transfer.** You may permanently transfer all of your rights under this EULA only as part of a sale or transfer of the SYSTEM, provided you retain no copies, you transfer all of the SOFTWARE (including all component parts, the media, any upgrades or backup copies, and this EULA), **and** the recipient agrees to the terms of this EULA. If the SOFTWARE is an upgrade, any transfer must include all prior versions of the SOFTWARE.
- **Termination.** Without prejudice to any other rights, Manufacturer or Microsoft may terminate this EULA if you fail to comply with the terms and conditions of this EULA. In such event, you must destroy all copies of the SOFTWARE and all of its component parts.

3. UPGRADES AND RECOVERY MEDIA.

- If the SOFTWARE is provided by Manufacturer on media separate from the SYSTEM and is labeled "For Upgrade Purpose Only"(Upgrade SOFTWARE"), you may install one copy of the Upgrade SOFTWARE onto the SYSTEM as a replacement copy for the SOFTWARE originally installed on the SYSTEM and use it in accordance with Section 1 of this EULA. You may also install additional copies of the Upgrade SOFTWARE as replacement copies onto additional SYSTEMS which are the same brand and model as the SYSTEM and contain a duly licensed copy of the same version and language release of the SOFTWARE("ADDITIONAL SYSTEMS"), provided that (1) Manufacturer has supplied a corresponding serialized sticker for each additional copy of the Upgrade SOFTWARE, and (2) you affix a serialized sticker per Manufacturer's instructions for each unit of Upgrade SOFTWARE you install.
- If the SOFTWARE is provided by Manufacturer on separate media and labeled as "Recovery Media", you may not make a copy of the SOFTWARE as described in Section 1 for archival purpose. Instead, you may use the Recovery Media solely to restore or reinstall the same version and language release of the SOFTWARE as originally installed on the SYSTEM and thereafter use the SOFTWARE as restored or reinstalled in accordance with Section 1 of this EULA. A single unit of Recovery Media may be used by you to restore or reinstall the SOFTWARE on ADDITIONAL SYSTEMS.

4. COPYRIGHT. All title and copyrights in and to the SOFTWARE (including but not limited to any images, photographs, animations, video, audio, music, text, and "applets" incorporated into the SOFTWARE), the accompanying printed materials, and any copies of the SOFTWARE are owned by Microsoft or its suppliers. You may not copy the printed materials accompanying the SOFTWARE. All rights not specifically granted under this EULA are reserved by Microsoft.

5. PRODUCT SUPPORT. Product support for the SOFTWARE is not provided by Microsoft or its subsidiaries. For product support, please refer to Manufacturer's support number provided in the documentation for the SYSTEM. Should you have any questions concerning this EULA, or if you desire to contact Manufacturer for any other reason, please refer to the address provided in the documentation for the SYSTEM.

6. LIMITED WARRANTY.

- **Limited Warranty.** Manufacturer warrants that the SOFTWARE will perform substantially in accordance with the accompanying written materials for a period of ninety (90) days from the date of receipt. Any implied warranties on the SOFTWARE are limited to ninety (90) days. Some states/jurisdictions do not allow limitations on duration of an implied warranty, so the above limitation may not apply to you.
- **Customer Remedies.** Manufacturer's and its suppliers' entire liability and your exclusive remedy shall be, at Manufacturer's option, either (a) return of the price paid, or (b) repair or replacement of the SOFTWARE that does not meet the above Limited Warranty and which is returned to Manufacturer with a copy of your receipt. This Limited Warranty is void if failure of the SOFTWARE has resulted from accident, abuse, or misapplication. Any replacement SOFTWARE will be warranted for the remainder of the original warranty period or thirty (30) days, whichever is longer.
- **No Other Warranties.** EXCEPT AS EXPRESSLY PROVIDED IN THE LIMITED WARRANTY SECTION ABOVE, THE SOFTWARE IS PROVIDED TO THE END USER "AS IS" WITHOUT WARRANTY OF ANY KIND, EITHER EXPRESSED OR IMPLIED, INCLUDING, BUT NOT LIMITED TO, WARRANTIES OF NON-INFRINGEMENT, MERCHANTABILITY, AND/OR FITNESS FOR A PARTICULAR PURPOSE. THE ENTIRE RISK OF THE QUALITY AND PERFORMANCE OF THE SOFTWARE IS WITH YOU.
- **No Liability for Consequential Damages.** MANUFACTURER'S SUPPLIERS SHALL NOT BE HELD TO ANY LIABILITY FOR ANY DAMAGES SUFFERED OR INCURRED BY THE END USER (INCLUDING, BUT NOT LIMITED TO, GENERAL, SPECIAL, CONSEQUENTIAL OR INCIDENTAL DAMAGES INCLUDING DAMAGES FOR LOSS OF BUSINESS PROFITS, BUSINESS INTERRUPTION, LOSS OF BUSINESS INFORMATION AND THE LIKE), ARISING FROM OR IN CONNECTION WITH THE DELIVERY, USE OR PERFORMANCE OF THE SOFTWARE.

U.S. GOVERNMENT RESTRICTED RIGHTS

The SOFTWARE and documentation are provided with RESTRICTED RIGHTS. Use, duplication, or disclosure by the Government is subject to restrictions as set forth in subparagraph (c)(1)(ii) of the Rights in Technical Data and Computer Software clause at DFARS 252.227-7013 or subparagraphs (c)(1) and (2) of the Commercial Computer Software-Restricted Rights at 48 CFR 52.227-19, as applicable. Manufacturer is Microsoft Corporation/One Microsoft Way/Redmond, WA 98052-6399.

If you acquired this EULA in the United States, this EULA is governed by the laws of the State of Washington.

If you acquired this EULA in Canada, this EULA is governed by the laws of the Province of Ontario, Canada. Each of the parties hereto irrevocably attorns to the jurisdiction of the courts of the Province of Ontario and further agrees to commence any litigation which may arise hereunder in the courts located in the Judicial District of York, Province of Ontario.

If this EULA was acquired outside the United States, then local law may apply.

Should you have any questions concerning this EULA, please contact the Manufacturer.

CE Conformity Marking

Anritsu affixes the CE Conformity marking on the following product(s) in accordance with the Council Directive 93/68/EEC to indicate that they conform to the EMC and LVD directive of the European Union (EU).

CE marking



1. Product Model

Model: MP1632C Digital Data Analyzer, and Expansion Unit

2. Applied Directive

EMC: Council Directive 89/336/EEC

LVD: Council Directive 73/23/EEC

3. Applied Standards

- EMC: Emission: EN 61326: 1997 + A1: 1998 + A2: 2001 + A3: 2003 (Class A)

Immunity: EN 61326: 1997 + A1: 1998 + A2: 2001 + A3: 2003 (Annex A)

	Performance Criteria*
IEC 61000-4-2 (ESD)	B
IEC 61000-4-3 (EMF)	A
IEC 61000-4-4 (Burst)	B
IEC 61000-4-5 (Surge)	B
IEC 61000-4-6 (CRF)	A
IEC 61000-4-8 (RPFMF)	A
IEC 61000-4-11 (V dip/short)	B

*: Performance Criteria

A: During testing normal performance within the specification limits.

B: During testing temporary degradation, or loss of function or performance which is self-recovering.

Harmonic current emissions:

EN 61000-3-2: 2000 (Class A equipment)

- LVD: EN 61010-1: 2001 (Pollution Degree 2)

C-tick Conformity Marking

Anritsu affixes the C-tick marking on the following product(s) in accordance with the regulation to indicate that they conform to the EMC framework of Australia/New Zealand.

C-tick marking



1. Product Model

Model: MP1632C Digital Data Analyzer, and Expansion Unit

2. Applied Standards

EMC: Emission: EN 61326: 1997 + A1: 1998 + A2: 2001 + A3: 2003
(ISM, Group 1, Class A equipment)

Power Line Fuse Protection

For safety, Anritsu products have either one or two fuses in the AC power lines as requested by the customer when ordering.

Single fuse: A fuse is inserted in one of the AC power lines.

Double fuse: A fuse is inserted in each of the AC power lines.

Example 1: An example of the single fuse is shown below:

Fuse Holder

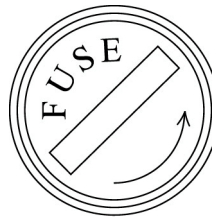

Example 2: An example of the double fuse is shown below:

Fuse Holders

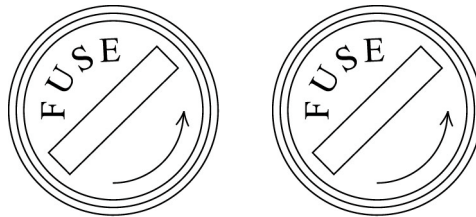

Introduction

Organization of Operation Manuals

The MP1632C Digital Data Analyzer is the main unit of the measuring equipment into which the plug-in units can be installed. Operation manuals have been prepared for the main unit and the other units, respectively, and consist of the following four Operation Manuals. Read the Operation Manual of the unit you are going to use.

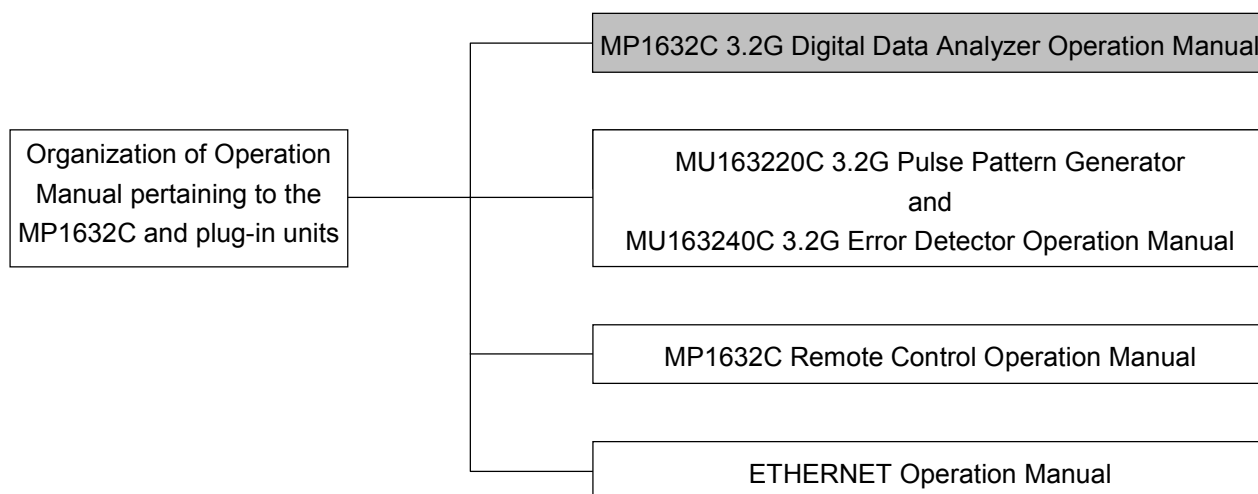

- **MP1632C Digital Data Analyzer Operation Manual**
This manual describes a brief overview, preparations before starting operation, the panel, specifications, performance, and operation procedures of the MP1632C and the internal 3.2G synthesizer option.
- **MU163220C 3.2G Pulse Pattern Generator and MU163240C 3.2G Error Detector Operation Manual**
This manual describes a brief overview, specifications, performance, and operation procedures related to the units of the 3.2G pulse pattern generator and the error detector.
- **MP1632C Remote Control Operation Manual**
This manual describes the controls using the external interface (RS-232C, GPIB option or Ethernet option) and sample programs.
- **ETHERNET operation manual**
This manual describes how to connect the MP1632C connect to LAN, using FTP, sample program which controls MP1632C via ethernet.

CONTENTS

CHAPTER 1 OVERVIEW	1
1.1 Product Overview	2
1.2 Structure of Operation Manual.....	3
1.3 Equipment Configuration	4
1.3.1 Standard Configuration.....	4
1.3.2 List of Units	5
1.3.3 List of Options	6
1.3.4 List of Related Products	6
1.4 Specifications	7
CHAPTER 2 SETUP	9
2.1 Ambient Conditions.....	10
2.2 Safety Precautions.....	11
2.3 Connecting the Power Cord.....	13
2.4 Running Applications Successfully	13
CHAPTER 3 PANEL DESCRIPTION AND CONNECTIONS	15
3.1 Panel Description	16
3.2 Connections.....	19
3.2.1 Sample connections of peripherals	19
3.2.2 Connecting peripherals.....	20
3.2.3 Connection between 3.2G internal synthesizer and Unit	22
CHAPTER 4 STARTING AND STOPPING THE MP1632C	25
4.1 Starting and Stopping the MP1632C.....	26
4.2 Definitions of Keywords	27
CHAPTER 5 DISPLAY DESCRIPTION	35
5.1 Kinds of Displays	36
5.2 Window Organization.....	38
5.2.1 Window hierarchy	38
5.2.2 Organization of panel display images	39
5.2.3 Toolbar organization	41
5.3 Opening and Closing Windows.....	42
5.3.1 Opening and closing subwindows and switching their displays	42
5.3.2 Switching panels	45
5.4 Basic Setup Procedures.....	46

5.5 Entering Data	47
5.6 Using Software Keyboard	51
5.6.1 Character Input	51
5.6.2 Setting the software keyboard	52
CHAPTER 6 OPERATING INSTRUCTIONS	55
6.1 Touch Screen Calibration	56
6.2 Saving and Opening Setup Data	57
6.2.1 Saving setup data	57
6.2.2 Opening setup data	60
6.2.3 Manipulating files	62
6.3 Choosing Remote Control	63
6.3.1 Choosing remote control interfaces	63
6.3.2 Setting RS-232C	64
6.3.3 Setting GPIB	65
6.3.4 Setting ETHERNET	66
6.4 Setting System Operations	67
6.5 Setting Date and Time	69
6.6 Setting Buzzer	71
6.7 Checking Occurred System Error	73
6.8 Viewing the Configuration of Units Inserted in the MP1632C	74
6.9 Printing Out Display Images	76
6.10 Resetting to Factory Defaults	77
6.11 Recovering Software	78
6.12 Using the MP1632C Menu	85
6.13 Setting a Frequency	88
6.14 Monitoring the System Error	90
6.15 For the Users of the Existing BERTS	91
6.15.1 Customize Subwindow	91
6.15.2 Assigning setting items to Setup frames	92
CHAPTER 7 PERFORMANCE TEST	93
7.1 Clock Output	94
7.1.1 Internal clock output	94
CHAPTER 8 MAINTENANCE • SCRAPPING	97
8.1 Daily Care	98
8.2 Storage Notes	98
8.3 Shipping	99

8.4 Calibration	99
8.5 Scrapping	99
APPENDIXES	101
Appendix A Display-specific Setup Items	102
Appendix B Troubleshooting	103
Appendix C Entry Table of Performance Test Result.....	105

CHAPTER 1 OVERVIEW

1.1 Product Overview

The MP1632C Digital Data Analyzer (hereafter simply called 'the instrument') is the mainframe into which various plug-in units can be installed to configure various systems. Combining the instrument and other units enabled various digital communication equipment, the modules such as O/E and E/O, and digital ICs to be evaluated. The instrument is suited for research, development and manufacturing.

Features

- User friendly operability
With Microsoft® Windows® Operating System support and a large color LCD screen, the instrument makes applications easier to understand and run.
- Operations on the display screen are possible using various tools
The various interfaces such as touch screen, mouse, and panel key can be used as the interface for operations on the display screen in order to achieve better operability of the main unit.
- Storage and read-out of mass data
The instrument has a built-in FDD and HDD as the data storage devices. Storage and read-out of various data such as setup information and results of measurements are possible.
- Various external interfaces are supported
RS-232C and GPIB (option) and Ethernet (option) are supported as the interface for remote control.
- The unit structure having the high expandability
Various systems can be configured, by combining the plug-in units. The expansion slots are prepared for easy upgrading when it becomes necessary in the future.

1.2 Structure of Operation Manual

The Operation Manual consists of the following nine chapters.

Chapter Number	Description
Chapter 1 Overview	Product overview, structure of operation manual, equipment configuration, and specifications
Chapter 2 Setup	Environmental conditions of installation location, safety precautions, preparations before turning on the power
Chapter 3 Panel Description and Connections	Layout of keys, LED, connectors of the MP1632C and their functional description
Chapter 4 Starting and Stopping the MP1632C	Starting up and shutting down the MP1632C, explanation of keywords in this manual
Chapter 5 Display Description	Structure and operation procedure of display
Chapter 6 Operating Instructions	Operation procedures of various functions
Chapter 7 Performance Test	Performance test items of internal 3.2G synthesizer option and procedure
Chapter 8 Maintenance · Scrapping	Preventive maintenance for safety, dairy maintenance, calibration, storage method, transportation method and disposal method
Appendix	Initial setting when shipped from the factory, troubleshooting and index

1.3 Equipment Configuration

1.3.1 Standard Configuration

The standard configuration of the instrument is shown in the following table.

Table 1-1 Standard configuration

Item	Model Name and Symbol	Product Name	Quantity	Remarks
Equipment configuration	MP1632C	Digital data analyzer	1	
Accessories supplied		Shielded power cord	1	
	F0090	Fuse	1	8A
	W1859AE	MP1632C operation manual	1	
	W1860AE	MP1632C remote control operation manual	1	
	Z0319A	PS/2 mouse	1	
	Z0320	Input pen	1	
	Z0396A	Pen Holder	1	
	Z0527	MP1632C Recovery Disk	1 set	
	Z0528	MP1632C Application Disk	1 set	
	Z0529	MP1632C Remote Sample Disk	1	
	J0905A	Semirigid cable	1	This is the supplied accessory of OPT03
	B0329D	Front cover	1	MW5U

1.3.2 List of Units

The plug-in units that can be inserted in the instrument are shown in the following table.

Table 1-2 List of units

Item	Product Name	Remarks
MU163220C	3.2G pulse pattern generator	The pulse pattern generator of the operating frequency in the range of 10 Mb/s to 3.2 G/s
MU163240C	3.2G error detector	Error detector of the operating frequency in the range of 10 Mb/s to 3.2 G/s

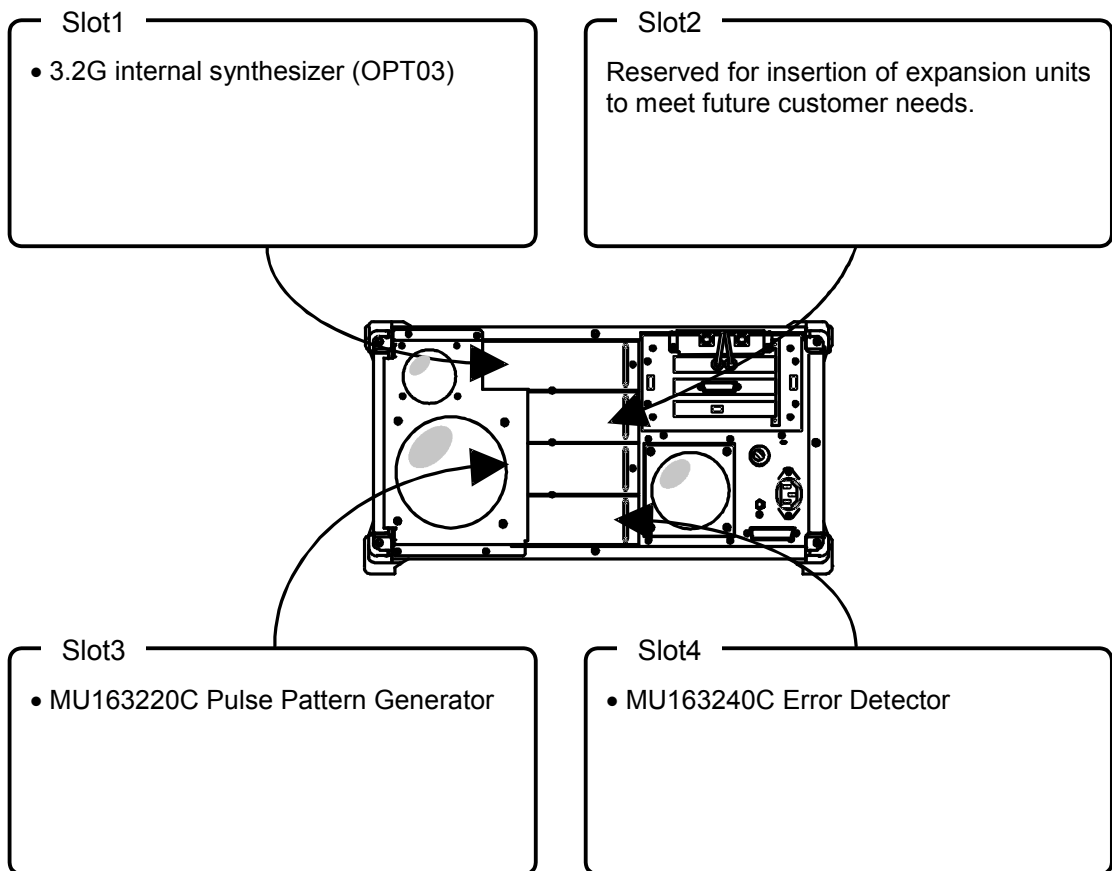

Fig 1-1 List of units

1.3.3 List of Options

The options that can be used in the instrument are shown in the following table.

Table 1-3 List of options

Item	Product Name	Remarks
MP1632C*01	GPIB	GPIB interface board
MP1632C*02	ETHERNET	Ethernet interface board
MP1632C*03	3.2G Internal Synthesizer	3.2GHz internal synthesizer

1.3.4 List of Related Products

The related products that can be used in the instrument are shown in the following table.

Table 1-4 List of related products

Item	Product Name	Remarks
Z0321A	keyboard	PS/2
J0008	GPIB connection cable	2.0m, 408JE-102
MB24B	Movable trolley	The rated current of power cord and plug:20A
B0348	Soft case	
B0493	Carrying case	
B0333D	Rack mount kit	
Z0398/Z0538	Ethernet Installation Disk	This is the supplied accessory of OPT02 Z0538: Board is 3ComCE, Z0398: Other than 3ComCE.
W1861AE	Ethernet Operation Manual	This is the supplied accessory of OPT02
B0447A	Dummy Unit for CG	
B0447B	Dummy Unit for Extension	
B0447C	Dummy Unit for PPG	
B0447D	Dummy Unit for ED	
Z0416	3.5 inch head cleaning disk	

1.4 Specifications

The specifications of the instrument are shown in Table 1-5.

The items marked by asterisk (*) require installation of options. Their contents are shown outside the table.

Table 1-5 Specifications (1/2)

Items	Specifications
OS	Microsoft® Widnows® operating system version 3.1
Screen display	Color LCD display (touch screen)
Size	10.4 inch, 640×480 dots
Display colors	256 colors
Printer	Parallel port
Connector	D-sub, 25-pins
Keyboard	English 101 type keyboard
Connector	PS/2 type, mini DIN 6-pins
Mouse	PS/2 mouse
Connector	PS/2 type, mini DIN 6-pins
Floppy disk drive	
Operation mode	Dual modes (1.44MB,740kB)
Usable disk	3.5 inch, 2HD/2DD
Hard disk drive	
Disk capacity	C drive : 474 MB or more (used for system: measurement data, pattern and others) D drive : 30MB (not accessible to users)
Interface	IDE interface
Remote control	
RS-232C	COM1
GPIB *1	IEEE488.2
Ethernet*2	10 Base T
Command	SCPI or MP1652/53 Compatible (Selectable)
Clock output*3	
Frequency range	50 MHz to 3.2 GHz (1 kHz steps)
Frequency accuracy	±2ppm
SSB phase noise	-85dBc/Hz or less (10kHz offset)
Non-harmonic spurious	-60dBc or less (however, measurement is limited to the spurious that is 10 kHz or more apart from the carrier frequency)
Connector	SMA

*1: Possible when OPT01 is installed

*2: Possible when OPT02 is installed

*3: Possible when OPT03 is installed

Table 1-5 Specifications (2/2)

Item	Specifications
Dimensions and weight Dimensions Weight	426(W), 221.5(H), 451(D) mm 20 kg or less (when no units are inserted, without OPT03) 25 kg or less (when no units are inserted, with OPT03)
Power supply Voltage Frequency Power consumption Operation temperature range	85 to 265 Vac 47.5 Hz to 63Hz 80 VA or less (when no units are inserted, without OPT03) 400 VA or less (with OPT03, MU163220C, MU163240C) +5 to +45°C

CHAPTER 2 SETUP

2.1 Ambient Conditions

The instrument operates under the ambient temperature of 5°C to 45°C, and ambient humidity of 85% or less. For storage, store the instrument under the ambient temperature of -20°C to 60°C, and ambient humidity of 85% or less. Avoid using the instrument in the following locations.

1. In places where the instrument will be subject to vibrations.
2. In places where much dust exists.
3. In places that receive direct sunlight.
4. In places where active gas exists.
5. In places where condensation may occur.

CAUTION

1. Do not block the air intake and air exhaust openings on the rear and the side of the instrument. Install the instrument unit so that the rear of the main unit is 10 cm or more away from the surrounding equipment and obstacles. If sufficient air intake and exhaust cannot be secured, internal temperature will rise and can cause failure of the instrument.
 2. When the instrument is used after storage for long hours in a low temperature, the circuitry can short due to dew condensation, causing failure. When the instrument is stored for long hours at a low temperature, start using the main unit after drying it sufficiently.
-
-

2.2 Safety Precautions

For safety assurance's sake, observe the safety precautions given below. For tips on starting and stopping the instrument, see Chapter 4, "Starting and Stopping the MP1632C."

WARNING

1. Before connecting the AC power cord, be sure to confirm that the POWER switch of the instrument is turned off. It can cause physical injury or electric shock.
 2. When the two-pole power outlet is used, be sure to connect the grounding terminal on the rear panel of the instrument cabinet to ground.
 3. Do not install or remove options and plug-in units by users themselves. Installation, removal, and replacement are performed by Anritsu service department. Contact your dealer or Anritsu sales office. It can cause physical injury or electric shock even to death.
-
-

CAUTION

1. The instrument operates on the power supply in the range of AC 85 V to 265 V (Frequency : 47.2 Hz to 63 Hz). Confirm the voltage and rating of the power supply carefully then connect the AC power cord.
 2. When connecting any signals to INPUT of the instrument, be careful that the excessive voltage exceeding the rating should not be applied. It can damage circuitry.
 3. Terminate the OUTPUT in 50 Ω . Never flow any current into the terminal.
 4. Before connecting any cables to the input and output connectors, be sure to connect the instrument and other equipment (inclusive of experimental circuit) with the grounding wires.
 5. The outer conductor and the core conductor of co-axial cable can form a capacitor between which electricity can be charged. Therefore, use the co-axial cable after discharging the electric charge by shorting the outer conductor and the core conductor with metal or a like.
 6. Connect the mouse, keyboard and printer when the main power of the instrument is turned off.
 7. The instrument has the hard disk in it. Do not give vibration or shock to the instrument to protect hard disk from damage.
-
-

CAUTION 

-
-
8. Do not turn off the main power of the instrument while the hard disk access lamp on the front panel is illuminating. If not, the hard disk can be damaged.
 9. Do not use anything other than the supplied unique pen and fingers to operate the touch panel.
 10. Never open the instrument. There can be a case that Anritsu cannot accept the maintenance work when the instrument is opened and the performance cannot be obtained.
 11. The memory backup battery of the instrument has the life about seven years. When a memory backup battery is used longer than the life, the information in the backup memory is lost, and the setup condition when the main power is turned off last time, cannot be resumed when the main power is turned on next time. Replace the memory backup battery in an earlier date.
-
-

2.3 Connecting the Power Cord

Check that the power switch on the front panel is turned off (switched to the (O) side). Insert the power plug into an outlet, and connect the other end to the power inlet on the rear panel. To ensure that the instrument is grounded, always use the supplied 3-pin power cord, and insert the plug into an outlet with a ground terminal.

WARNING

If the power cord is connected without the instrument grounded, there is a risk of receiving a fatal electric shock. In addition, the peripheral devices connected to the instrument may be damaged. When connecting to the power supply, DO NOT connect to an outlet without a ground terminal. Also, avoid using electrical equipment such as an extension cord or a transformer.

CAUTION

If an emergency arises causing the instrument to fail or malfunction, disconnect the instrument from the power supply by either turning off the power switch on the front panel (switch to the (O) side), or by pulling out the power cord or the power inlet.

When installing the instrument, place the instrument so that an operator may easily operate the power switch.

If the instrument is mounted in a rack, a power switch for the rack or a circuit breaker may be used for power disconnection.

2.4 Running Applications Successfully

In addition to the Microsoft® MS-DOS® Operating System and Microsoft® Windows® Operating System, the instrument has device control drivers and other software installed.

While you can make alterations to the Windows® operating environment via Control Panel or Windows setup program, successful functioning of the application would be unpredictable if any alteration is made beyond the scope of alterations mentioned in this operation manual.

Do not make alterations to the Windows® operating environment for any other purpose or in any other method than those mentioned in this operation manual.

(Blank)

CHAPTER 3 PANEL DESCRIPTION AND CONNECTIONS

3.1 Panel Description

The view of the instrument's front and rear panels are shown below, along with a summary description of their component functions.

Front panel

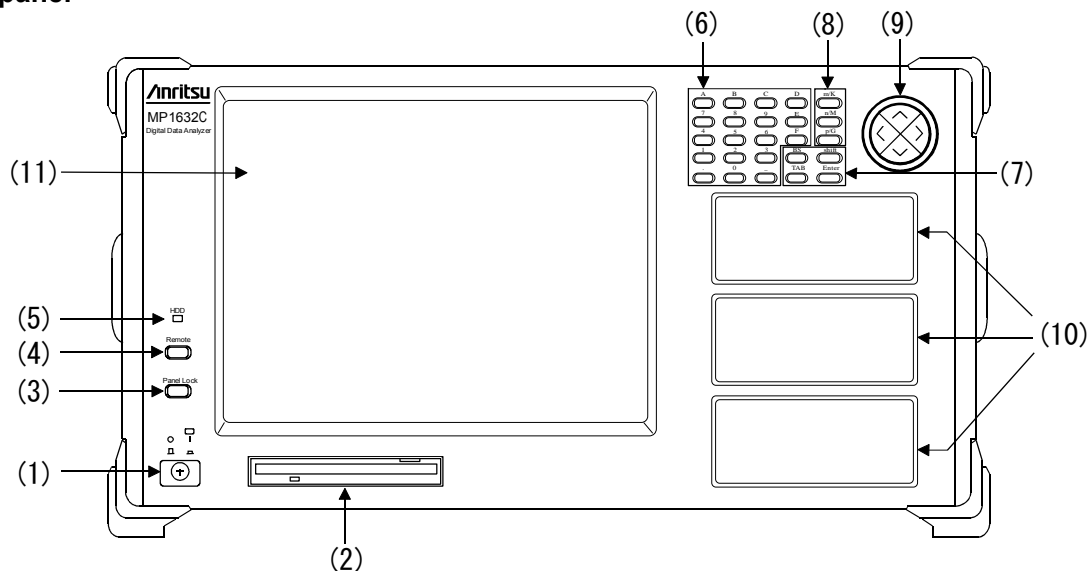

Fig. 3-1 Front Panel

Number	Label	Name	Description
1		Power switch (with a power-on LED)	Turns AC power on or off.
2		Floppy disk drive	3.5-inch FDD. Dual modes: 2DD (720 KB) and 2HD (1.44 MB)
3	Panel Lock	Panel lock key	Disables front-panel operations. The LED is on when the front panel is locked.
4	Remote	Local key (with a remote LED)	Switches the instrument from the remote mode to the local mode. The LED is on when the instrument is in the remote mode.
5	HDD	Hard disk drive access LED	Lights when access to the hard disk drive is in progress.
6	[0] through [9], [-], [.] and [A] through [F]	Numeric value entry keys	Enter numeric values.
7	Tab, Shift, BS, Enter	Display control keys	Accept entries, move the focus, and otherwise control displays.
8	m/k,n/M,p/G	Unit keys	Select units for entering numeric values.
9		Rotary encoder (with up, down, left, and right keys)	Alter numeric values continuously. The up, down, left, and right keys are used mainly to move the highlighted cursor.
10		Slots 2 to 4	The front panels of the units inserted in slots 2 to 4 appear at this position.
11		Color LCD	Display with a touch screen, that displays setup items and measurement data.

Rear Panel

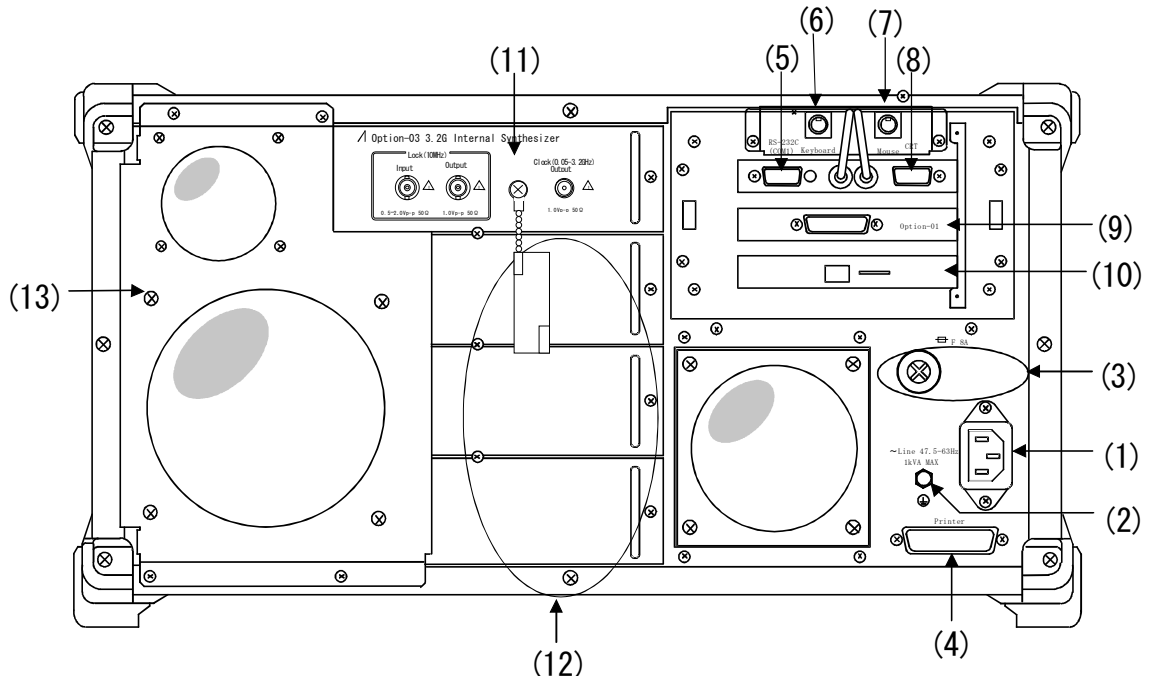

Fig. 3-2 Rear Panel

Number	Label	Name	Description
1		AC power connector	AC power connector
2		Functional earth terminal	Functional earth terminal
3		Fuse holder	AC power fuse holder
4	Printer	Printer connector	Connector to which an external printer is connected
5	RS-232C(COM1)	RS-232C connector	Connector used to connect an external controller to the instrument via an RS-232C interface
6	Keyboard	Keyboard	Connector to which the keyboard is connected
7	Mouse	Mouse connector	Connector to which the mouse is connected
8	CRT	VGA connector	Connector to which an external display is connected
9	GPIB (OPT01)	GPIB connector	Connector used to connect an external controller to the instrument via an GPIB interface
10	ETHERNET (OPT02)	10BaseT(RJ-45) connector	Connector used to connect an external controller to the instrument via an ETHERNET interface
11		Slot1	Slot in which 3.2G internal synthesizer option is inserted
12		Slots 2 to 4	Slots in which plug-in units are inserted
13		Fan	Cooling fan

The view of the 3.2G internal synthesizer (OPT03) rear panel is shown below, along with a summary description of its component functions.

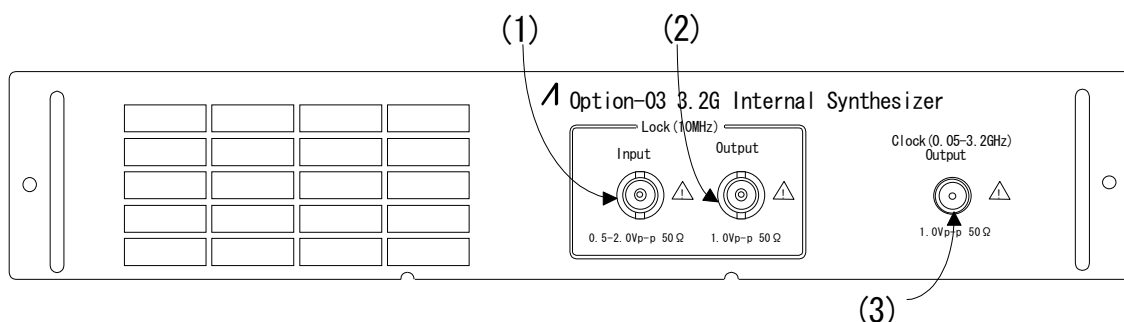

Fig. 3-3 Rear Panel of 3.2G internal synthesizer

Number	Label	Name	Description
1	Lock (10MHz) Input	Reference clock input connector	Used to synchronize an external 10MHz reference signal with the clock of this synthesizer. Frequency : 10MHz \pm 10ppm Level : 0.5Vp-p to 2.0Vp-p Termination condition : 50 Ω to GND Waveform : Square wave or sine wave
2	Lock(10MHz) Output	Reference clock output connector	Outputs 10MHz reference clock pulses to synchronize the clock of external equipment with the clock of this synthesizer. Frequency : 10MHz \pm 2ppm Level : 1.0Vp-p \pm 20% (AC) Termination condition:50 Ω to GND
3	Clock(0.05-3.2GHz) Output	Clock output connector	Outputs the clock signal generated by this synthesizer Level : 1.0Vp-p \pm 30% Termination condition : 50 Ω to GND Duty : 50 \pm 5%

3.2 Connections

3.2.1 Sample connections of peripherals

A mouse, a keyboard, a printer, an external display, and a personal computer (used as a controller) can be connected to the instrument's rear panel. Sample connections are shown below.

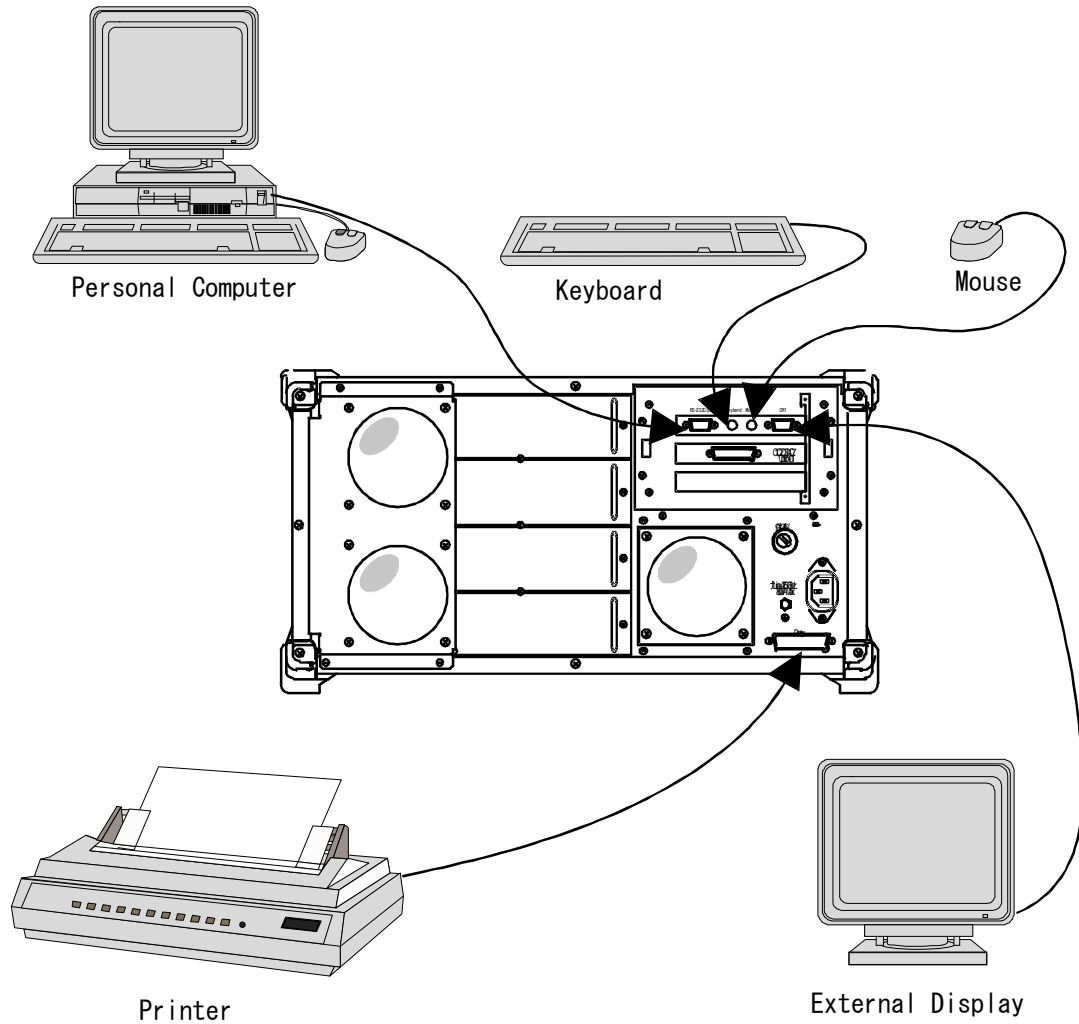

Fig. 3-4 Connecting peripherals and external instruments

3.2.2 Connecting peripherals

Procedures for connecting peripherals to the instrument are described below, along with tips.

■ Mouse

Connect the PS/2 mouse (supplied with the instrument as a standard accessory) to the rear-panel mouse connector while the instrument is off, and then turn it on. The mouse becomes operable when the application starts running.

To enter detailed mouse settings (such as moving speed and double click intervals), select Mouse from Microsoft® Windows® Operating System Control Panel.

Note

Control Panel can be opened by double-clicking the Control Panel icon from the Microsoft Windows® Main group.

■ Keyboard

Connect the 101-key keyboard to the rear-panel keyboard connector while the instrument is off, and then turn it on. The keyboard becomes operable when the application starts running.

To enter detailed keyboard settings (such as the auto-repeat function), select Keyboard from Windows® Control Panel

Note

To connect any other keyboard than the 101-key keyboard, select the Windows Setup program from the Windows® Main group.

■ Printer

Connect a printer to the rear-panel printer connector while the instrument is off, and then turn it on. When the application has started running, select Printers icon from Windows® Control Panel to set the printer up.

Note

The message of “Insert Microsoft Windows 3.1 Disk #5 ...” may be displayed while setting the printer via Printers of Control Panel. In this case, insert the attached Recovery Disk to FDD.

The table below define the disk number of Recovery Disk corresponding to displayed disk number by the message.

Displayed disk number by the message	1	2		5	6
Disk number of Recovery Disk	5	6		9	10

■ External display

An external display connected to the instrument provides high-resolution display images. To connect an external display to the instrument, follow these steps.

1. Connect an external display to the rear-panel VGA connector while the instrument is off.
2. Turn on the instrument. The application will display on both the LCD on the instrument's front panel and on the CRT screen of the external display.
3. Select the ChipsCLP icon from Windows® Control Panel and run the Display Driver Control Panel program.
4. Select a resolution, number of colors, and font size to set the required screen condition, then specify "CRT" in the "Display" group box.
5. The setting has been completed. Press the OK button; the Display Driver Control Panel program exits.

Note

When you select either the CRT or LCD in the Display group box setting of the Display Control panel program, the other not displayed. For example, when you select the CRT, the LCD on the instrument's front panel is disabled; when you select the LCD, the CRT screen of the external display is disabled.

3.2.3 Connection between 3.2G internal synthesizer and Unit

This section describes how to connect 3.2G internal synthesizer to another unit inserted in the MP1632C.

- **Connection between 3.2G internal synthesizer and PPG**

Slot3 : MU163220C 3.2G pulse pattern generator

Cable : SMA cable

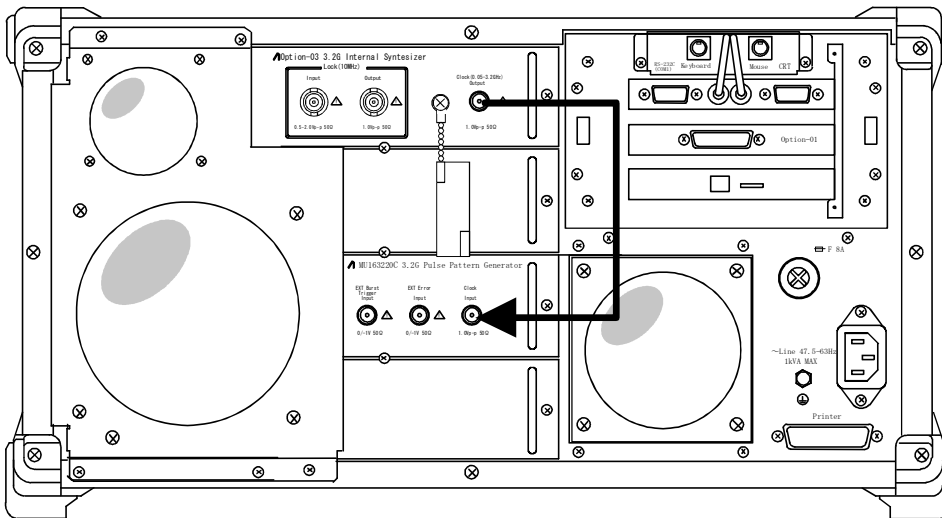

Fig. 3-5 Connection between internal synthesizer and PPG

- **Connection from peripherals**

Cable : BNC cable

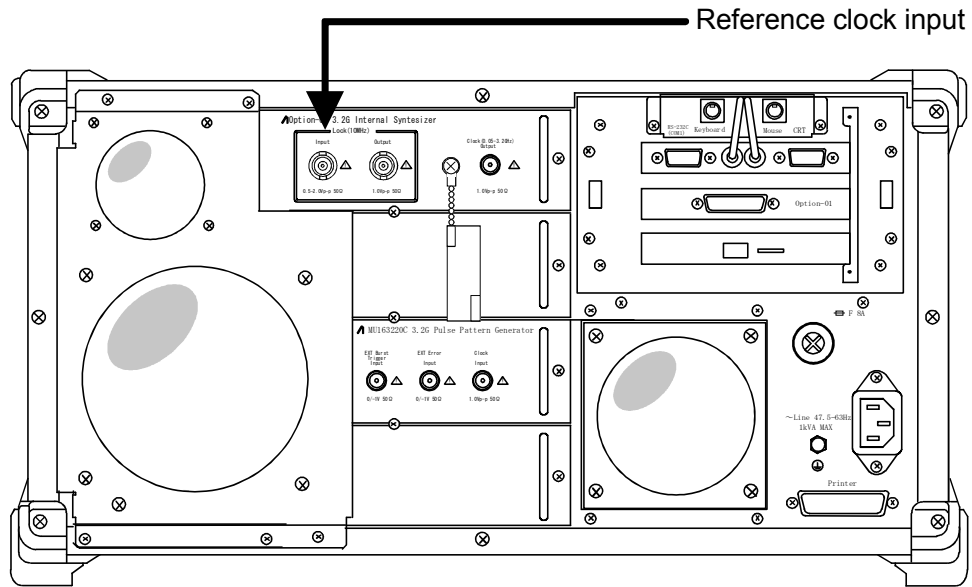

Fig. 3-6 Connection from peripherals

- **Connection to peripherals**

Cable : BNC cable

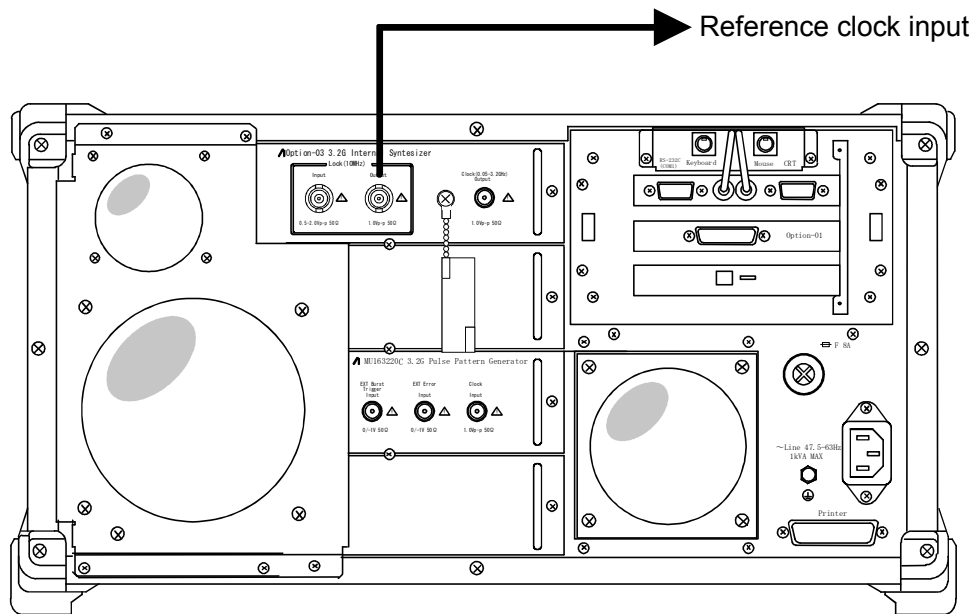

Fig. 3-7 Connection to peripherals

(Blank)

CHAPTER4 STARTING AND STOPPING THE MP1632C

4.1 Starting and Stopping the MP1632C

Microsoft® MS-DOS® Operating System and Microsoft® Windows® Operating System (hereafter simply called Windows®) are used as display control software in the instrument, so that you can run the application for the instrument the same way as you do applications on Windows®. This section describes how to start and stop the instrument.

Starting the MP1632C

There are two ways to start the instrument:

- Turn on the power.
Turn on the instrument. The system will start up and the application will run automatically.
- Start from the Windows® program manager.
Double-click the MP1632C Digital Analyzer icon in the program manager's MP1632C group, causing the application to start running.

Note

The instrument stores, in its internal memory, the status in which it had been when it was last turned off. This status is resumed when it is turned on.

The remote/local status and the panel lock state are initialized.

(Remote/local status:Local Panel lock state:OFF)

Stopping the MP1632C

To stop the instrument, follow these steps:

1. Select [File]-[Exit] from the parent window menu bar. The application will terminate, with only Windows® operating.
2. Select [File]-[Exit Windows] from the Windows® program manager. Windows® will terminate.
3. When Windows® terminates, the MP1632C program menu opens. Turn off the power in this state.

CAUTION

1. Damage to the hard disk might result if the instrument is stopped in any other way (such as turning off the front-panel power switch while the instrument is functioning). To protect the hard disk, use the method suggested above to stop the instrument, except in times of emergencies (such as a power failure or inadvertent disconnection of the instrument from the AC receptacle). For safeguards against power failures, see the section 6.4 "Setting System Operations".
 2. Do not turn off the instrument while access to the hard disk drive is in progress (with the access lamp is lit). Damage to the hard disk could result.
-
-

4.2 Definitions of Keywords

Because the instrument supports Windows®, Windows® terms are sometimes used in its context in this user's guide. Windows® terms and operations frequently mentioned in this guide are defined below.

General terms

General terms appearing in the user's guide are defined below. (The use of a mouse is assumed.)

- **Mouse pointer**
An on-screen graphic object that designates the location of the mouse on the screen. The mouse pointer varies in its shape to an arrow, hour glass and so on depending on its location or the operation of the application.
- **Click**
The process of pressing and then releasing a left mouse button at a given position.
- **Double-click**
The process of pressing a left mouse button twice in rapid succession at a given position.
- **Drag**
The process of moving the mouse while holding down a left mouse button.
- **Drop**
The process of releasing the left mouse button after dragging.
- **Control**
Refers to an object placed on the screen, such as a button or text box. Controls are used to present data or choose items.
- **Focus**
The state of being ready to receive the next input is called "having focus." For example, when several controls exist on the screen, the focus is designated by a box in dotted lines or by highlighting.

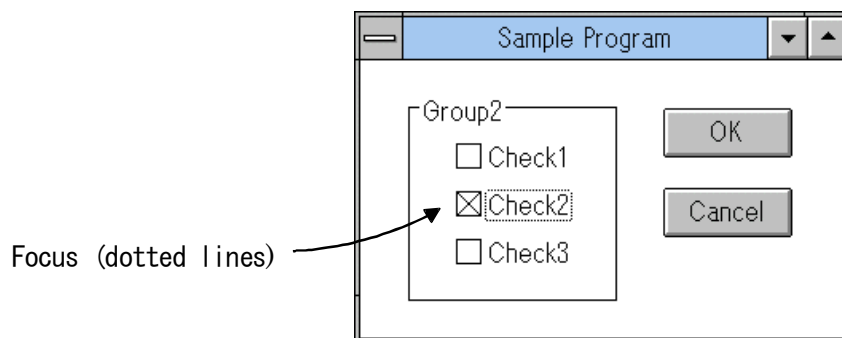

Fig. 4-1 Focus at a Check Box

Note

The instrument has a touch screen, which can be operated by touching it. Touch screen operations are essentially similar to mouse operations, except that the function of the right mouse button is not supported. Think of the function of pressing the left mouse button as touching the screen surface with the input pen.

Window elements

The elements of a window are shown below.

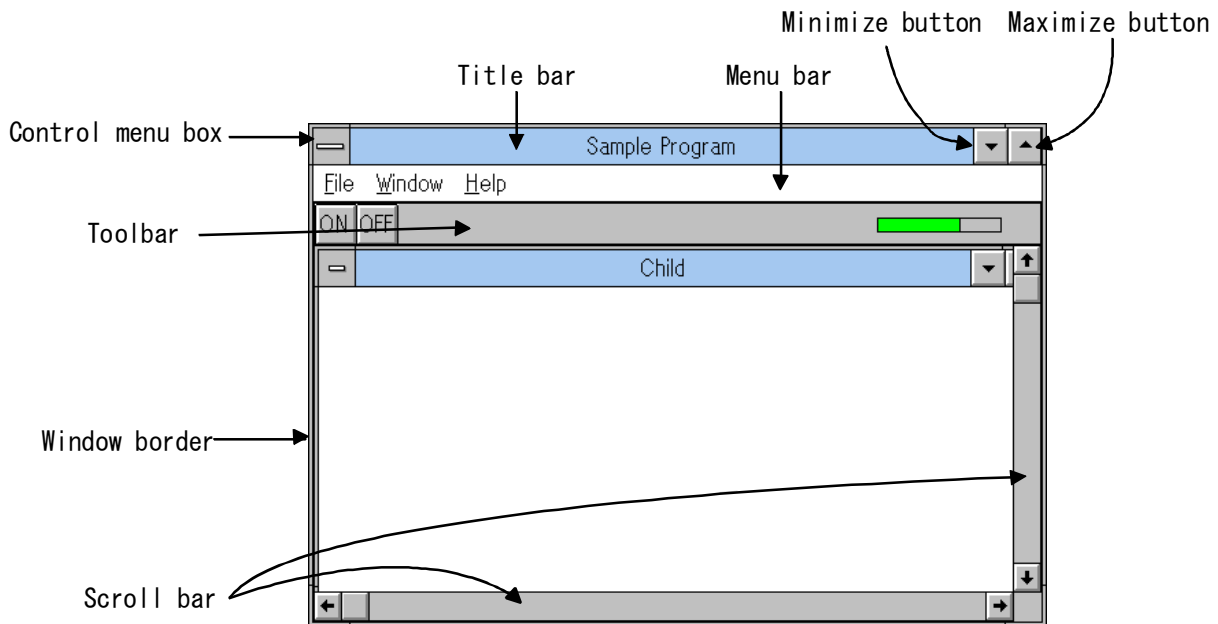

Fig. 4-2 Window Elements

- Title bar
Contains the title, control menu box, minimize button, maximize button and so on.
- Title
Refers to the label that denotes the window function.

- Control menu box
Click to open the control menu, from which the window can be maximized, minimized, and so on. Additionally, to close the window double-click it.

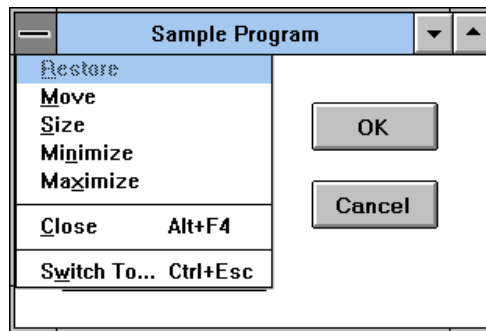

Fig. 4-3 Control menu

- Minimize button
Click to minimize the window, normally as an icon.
- Maximize button
Click to maximize the window.
- Menu bar
Refers to an area containing menu titles.
- Menu title
Refers to a character string appearing on the menu bar. When you click a menu title, a drop-down menu opens. Choose a menu action from the menu and click it to execute the associated function (Fig. 4-4).

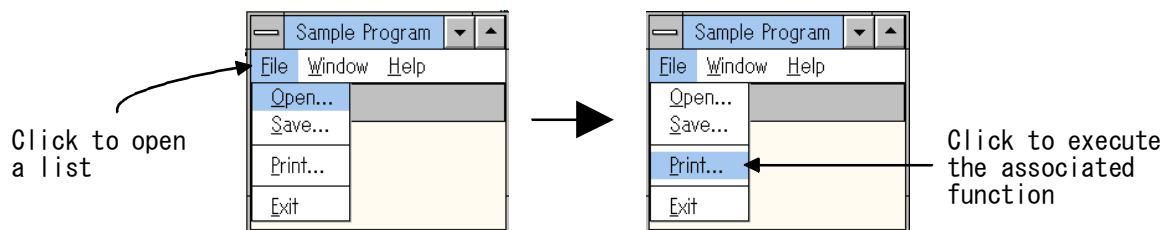

Fig. 4-4 Selecting Menu Functions

Menu actions may have choices of items. When an item is selected, it is marked by a check mark (Fig. 4-5).

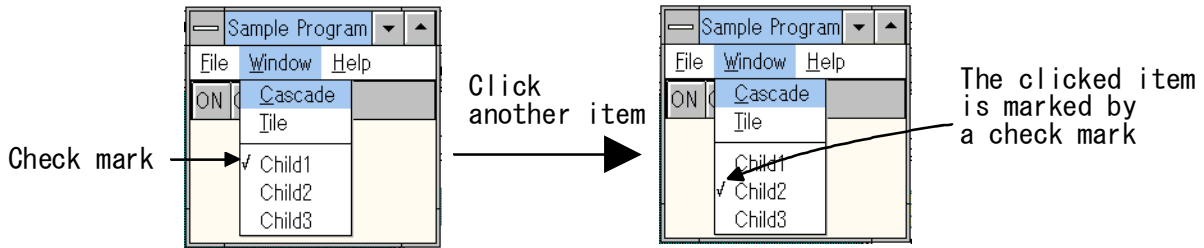

Fig. 4-5 Menu with a Check Mark

- **Toolbar**
Refers to an area in which frequently used functions are represented, as by buttons.
- **Scroll bar**
When not all of the information on the screen can be displayed in a single display image, a scroll bar appears. Move the scroll bar to manipulate hidden information into view.
- **Window border**
Refers to a boundary line for a single window.

Window manipulations

Basic window manipulations are described below.

- **Minimize a window**
Click the minimize button to reduce the window to an icon.
- **Maximize an icon**
To maximize an icon, point to the icon and double-click it.

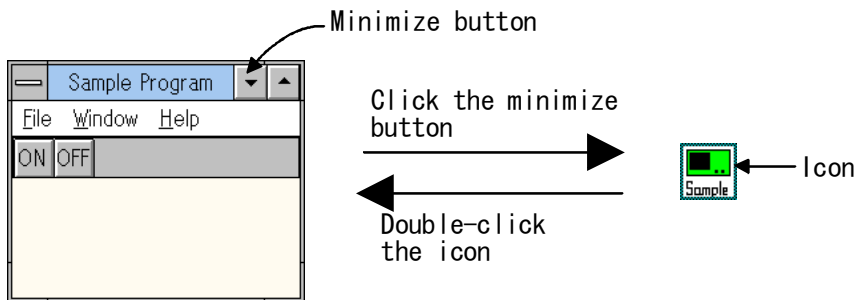

Fig. 4-6 Icon and Window Displays

- To maximize a window
Click the maximize button in the window, and the window will be enlarged to the full size of the screen. The window will also be maximized by double-clicking the title bar. When the window is maximized, the maximize button changes to a restore button to restore the window to its original size.
- To return a maximized window to its original size
To return a maximized window to its original size, click the restore button or double-click the title bar

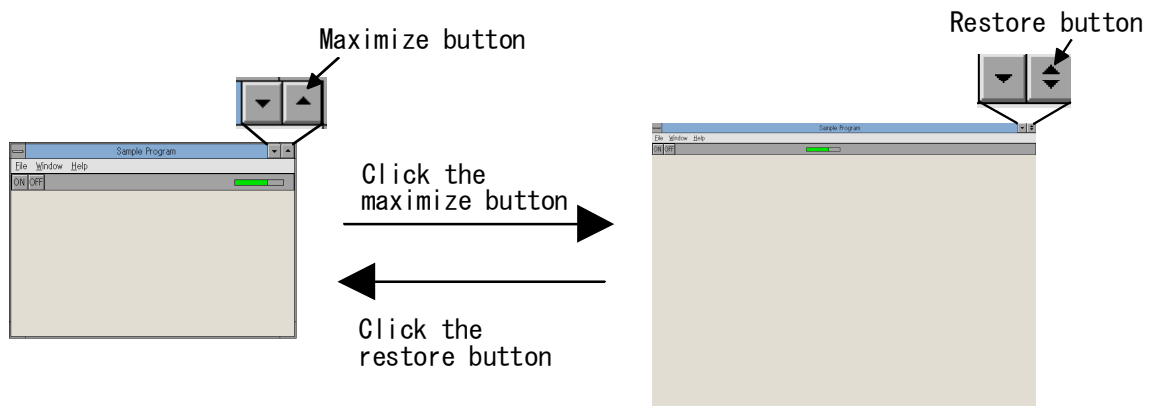

Fig. 4-7 Maximize Action, and Restoring to Original Window Size

- To resize a window
Point to a boundary of the window and an arrow will appear, permitting you to resize the window in the indicated direction. Drag the mouse while holding down the left button, releasing it when the window has changed to the desired size.
- To move the display position of a window
Point to the title bar in the window and hold the left mouse button pressed. Then, drag the mouse to the position where you want the window placed, and release the left mouse button.
- To move the position of an icon
Point to the icon and hold the left mouse button pressed. Then, drag the mouse to the position where you want the icon placed, and release the left mouse button.
- To move the focus from one control to the next
To move the focus to one of the multiple controls existing in a single window, click that control. The control thus clicked will become the focus. Alternatively, press the [Tab] key, or the [Shift] + [Tab] key. The focus will move from one control to the next in the window.

Controls

The controls used with the instrument are defined below.

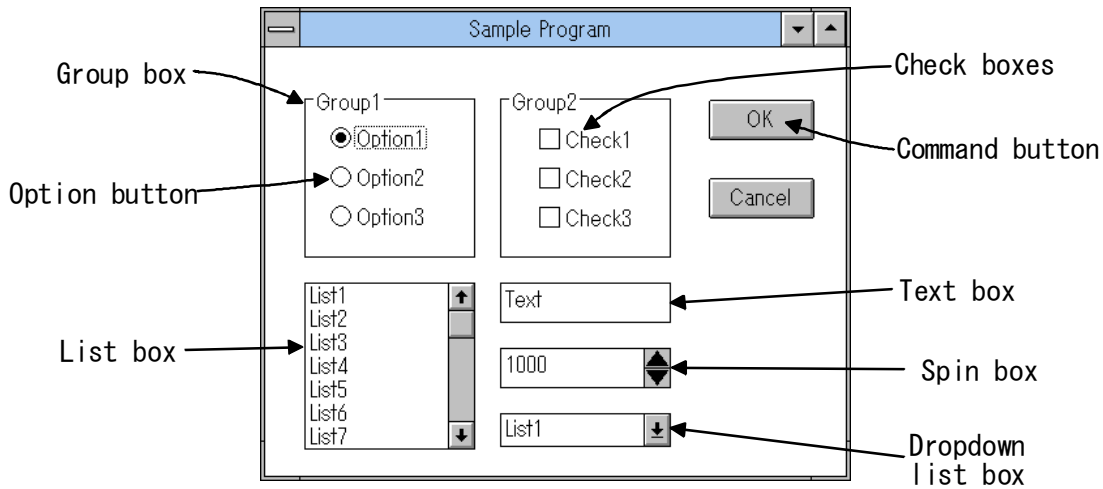

Fig. 4-8 Control

- **Command button**
A rectangular button labeled with a function name. Click to execute the associated function. (The instrument also supports toggle buttons, which assume either of the two states, pressed or released, and radio buttons only one of which can be selected at a time.)
- **Option button**
A round button used to select one out of a group of mutually exclusive options. When an option button is selected, it is marked by a black circle appearing in it. Normally, a set of similar options are placed in a single group box, out of which one is selected
- **Check box**
A square box that is selected or cleared to turn on or off an option. When a check box is selected, it is marked by a check mark appearing in it.
- **List box**
Any type of box containing a list of items available for selection. Click-select one of the items in the list. When an item is selected, it is highlighted. Two types of list boxes available are the standard list box, from which only one item can be selected, and the multiple choice list box, from which two or more can be selected.
- **Drop-down list box**
Similar in function to the list box mentioned above. Usually, only the selected item is displayed. Click the arrow to display the list, then click-select one of the items in the list.
- **Text box**
A rectangular box in which text can be entered or edited. Enter or edit text at the cursor in the text box.
- **Spin box**
A text box with up and down arrows, used to move through a set of fixed values. Valid values may also be typed directly in the spin box using front-panel numeric keys.

- Group box
A frame or box that encloses a set of related controls.

(Blank)

CHAPTER 5 DISPLAY DESCRIPTION

5.1 Kinds of Displays

The instrument has a number of setup displays and windows, which can be grouped into four broad categories according to their operation and functions. In this user's guide, these displays and windows are called by the names mentioned below.

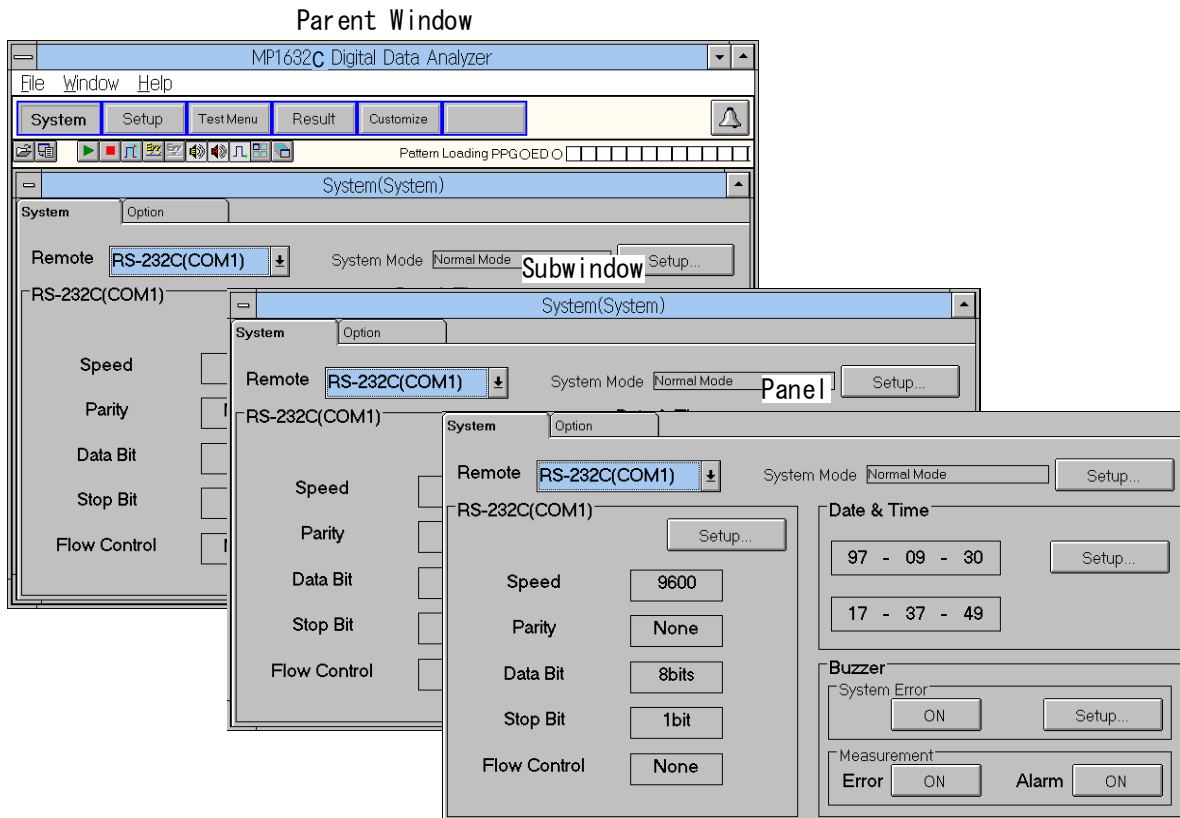

Fig. 5-1 Kinds of displays

- Parent window
The first window that the application opens when it starts running. You can open subwindows or exit the application from the parent window.
- Subwindow
A window that can be opened by clicking a subwindow open/close button in the parent window. Subwindows contains some panels.
- Panel
A window that is opened by switching tabs in a subwindow. Various settings and measurement data appear on panels.

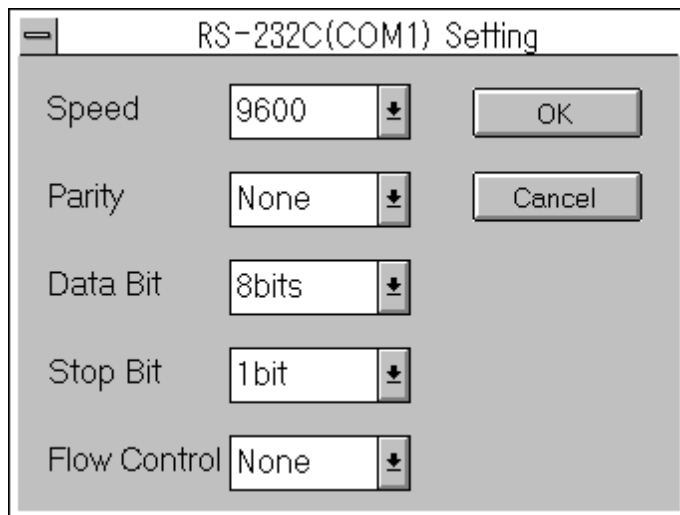

Fig. 5-2 Dialog box

- Dialog box

A window that is opened by clicking a command button or selecting a menu on a panel. Once you open a dialog box with the instrument, you cannot operate other window unless you close it. Dialog boxes are normally used to modify settings.

5.2 Window Organization

5.2.1 Window hierarchy

The hierarchy of the parent window, subwindows, and panels supported by the instrument with a 3.2G internal synthesizer (OPT03), a pulse pattern generator (PPG), and an error detector (ED) unit installed in it. For descriptions of the shaded displays in the table below, refer to the MU163220C 3.2G Pulse Pattern Generator and MU163240C 3.2G Error Detector operation manual.

Table 5-1 Window Hierarchy

Subwindow	Panel	Setup item
System	System	Sets the date and time, remote control functions, and system operation mode.
	Option	Displays the configuration of the units installed in the instrument.
Setup	Setup	Sets basic setup items.
	Frequency	Sets the frequency
	Clock I/F	Sets the clock I/O interface.
	Data I/F	Sets the data I/O interface.
	Pattern	Sets transmitted/received patterns, bursts, and synchronization.
	Trigger I/F	Sets trigger/sync I/O signals.
	Utility	Sets the others
Test Menu	Measurement	Sets measurement conditions.
	Error Addition	Sets error addition and delay measurement pattern insertion conditions.
Result	Error/Alarm	Displays error/alarm measurement data and starts or stops measurement.
	Eye Margin	Displays eye margin measurement data and starts or stops measurement.
Customize		Displays setup and error measurement data (item selection and setup by immediate value entry).

5.2.2 Organization of panel display images

The instrument can house a number of units. Setup and measurement data information is available in a unit-specific manner. Panels display setup and measurement data information in the following organizations:

- Displaying information on multiple units installed
Information on the units inserted in slots 3 and 4 is displayed on a single panel at the same time. Unit-specific information (as on the 'Setup:Clock I/F' panel and the 'Setup:Data I/F' panel) may be displayed in two group boxes (Fig. 5-3) or in one group box (Fig. 5-4).

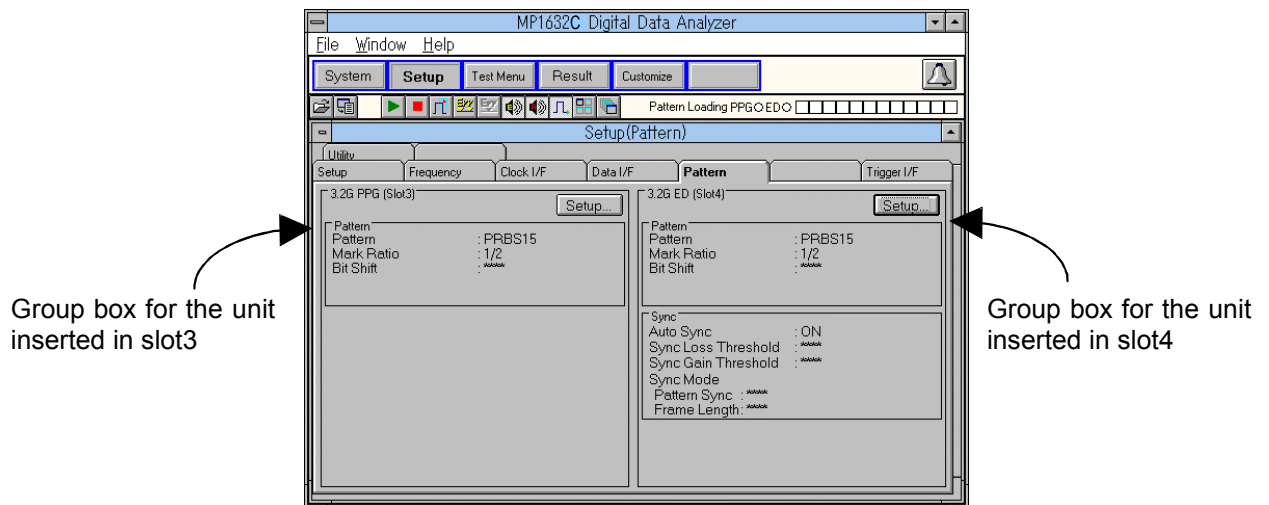

Fig. 5-3 Displaying Information on Multiple Units (Unit-specific group boxes)

- Displaying information on a single unit and the instrument
The 'Setup:Frequency' panel, the 'Result:Eye Margin' panel, and so on each display information on one unit at a time. Unlike the organization described above, no unit-specific group boxes exist in this case.

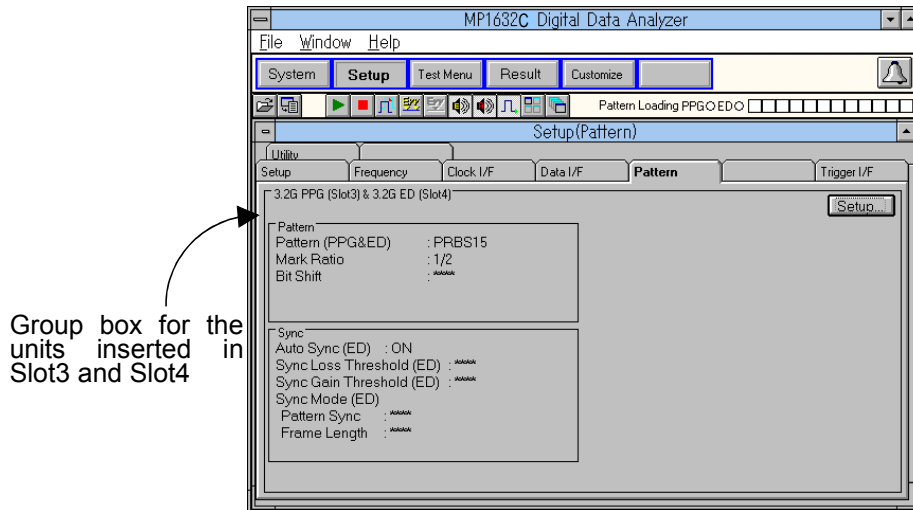













Fig. 5-4 Displaying Information on Multiple Units (Common group box)

5.2.3 Toolbar organization

The instrument provides a number of icons on the toolbar. The icons are in the form of buttons associated with frequently used functions. When buttons are pressed, their corresponding functions are executed. The table below defines the functions corresponding to the icons. Some icons are disabled when PPG or ED is not installed in the instrument.

Button	Function	Corresponding command
	Opens a file.	Menu bar [File]-[Quick Open]
	Hard copies a display image.	Menu bar [File]-[Hard Copy]
	Starts measurement.	Result subwindow Start button
	Stops measurement.	Result subwindow Stop button
	Executes an auto search.	Result subwindow Auto Search button
	Adds a cyclic error.	'Test Menu:Error Addition' panel Error Add button
	Adds a single error.	'Test Menu:Error Addition' panel Single button
	Sets the ON/OFF status of the error beeper.	ON/OFF status setting of the 'System:System' panel error beeper
	Sets the ON/OFF status of the alarm beeper.	ON/OFF status setting of the 'System:System' panel alarm beeper
	Sets the ON/OFF status of all output signals.	ON/OFF status setting of the 'Setup:Clock' and 'Setup:Data' panel output.
	Relocates windows (Tile).	Menu bar [Window]-[Tile]
	Relocates windows (Cascade).	Menu bar [Window]-[Cascade]

5.3 Opening and Closing Windows

5.3.1 Opening and closing subwindows and switching their displays

Procedures for opening and closing subwindows and switching their displays are described.

Opening and closing a subwindow

To open a subwindow

Click a subwindow open/close button in the parent window. The subwindow associated with the button label will open.

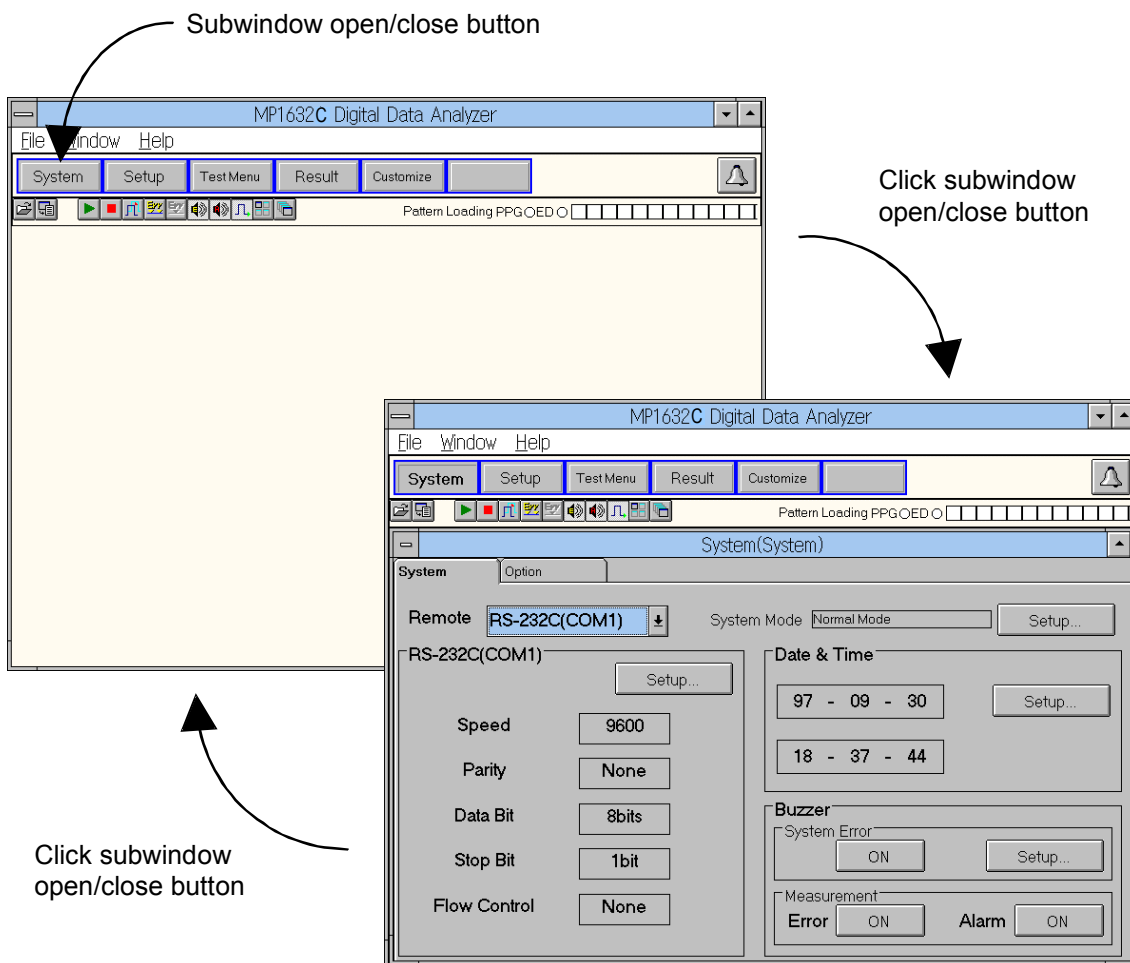

Fig. 5-5 Opening and Closing a Subwindow

- To close the subwindow
Click the subwindow open/close button again. The subwindow associated with the button label will close.
- To open multiple subwindows concurrently
You can open multiple subwindows concurrently. Click the buttons corresponding to the subwindows to open.

Switching subwindow displays

You can maximize an open subwindow or switch its display.

- To maximize a subwindow
Click the maximize button. The subwindow will then be maximized in the parent window.
- To return a maximized subwindow to its original size
When a subwindow is maximized, the maximize button changes to a restore button. To return the maximized subwindow to its original size, click the restore button.

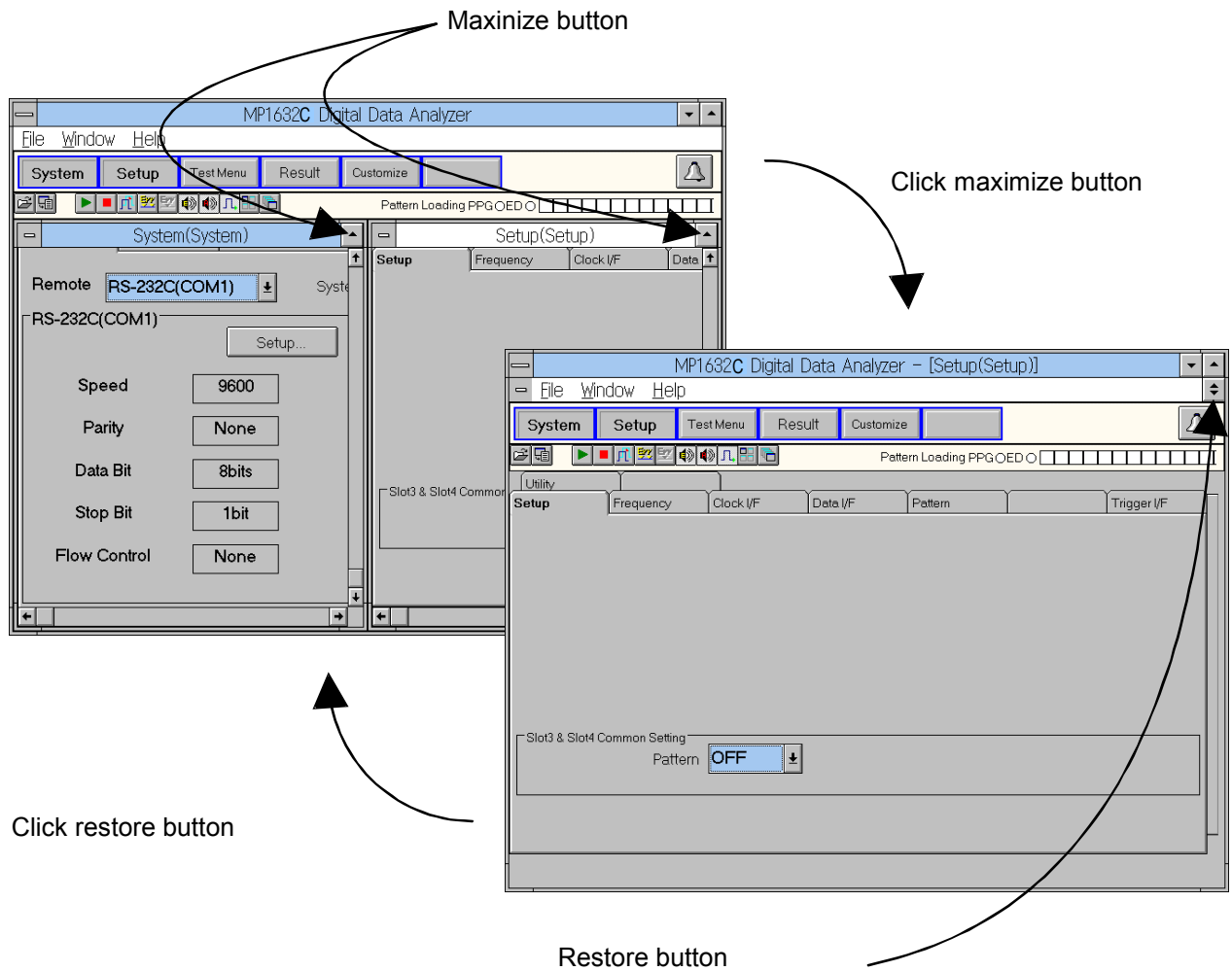

Fig. 5-6 Maximizing a Subwindow

- To display open subwindows side by side
Select [Window]-[Tile] from the parent window menu bar. Multiple open subwindows will be displayed, side by side, in the parent window.

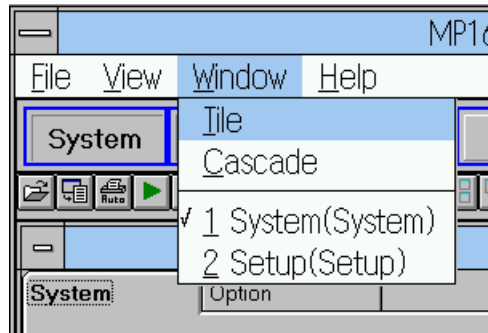

Fig. 5-7 WindowMenu

- To display open subwindows overlapped
Select [Window]-[Cascade] from the parent window menu bar. Multiple open subwindows will be displayed, overlapped, in the parent window.
- To move the focus to a subwindow
Click inside the window frame of the subwindow to which the focus is to be moved. Alternately, select [Window]-[Subwindow Name] from the parent window menu bar. The subwindow thus selected will become the focus, with its title bar being highlighted.

5.3.2 Switching panels

Subwindows contain multiple panels each. You cannot view multiple panels of a single subwindow at once.

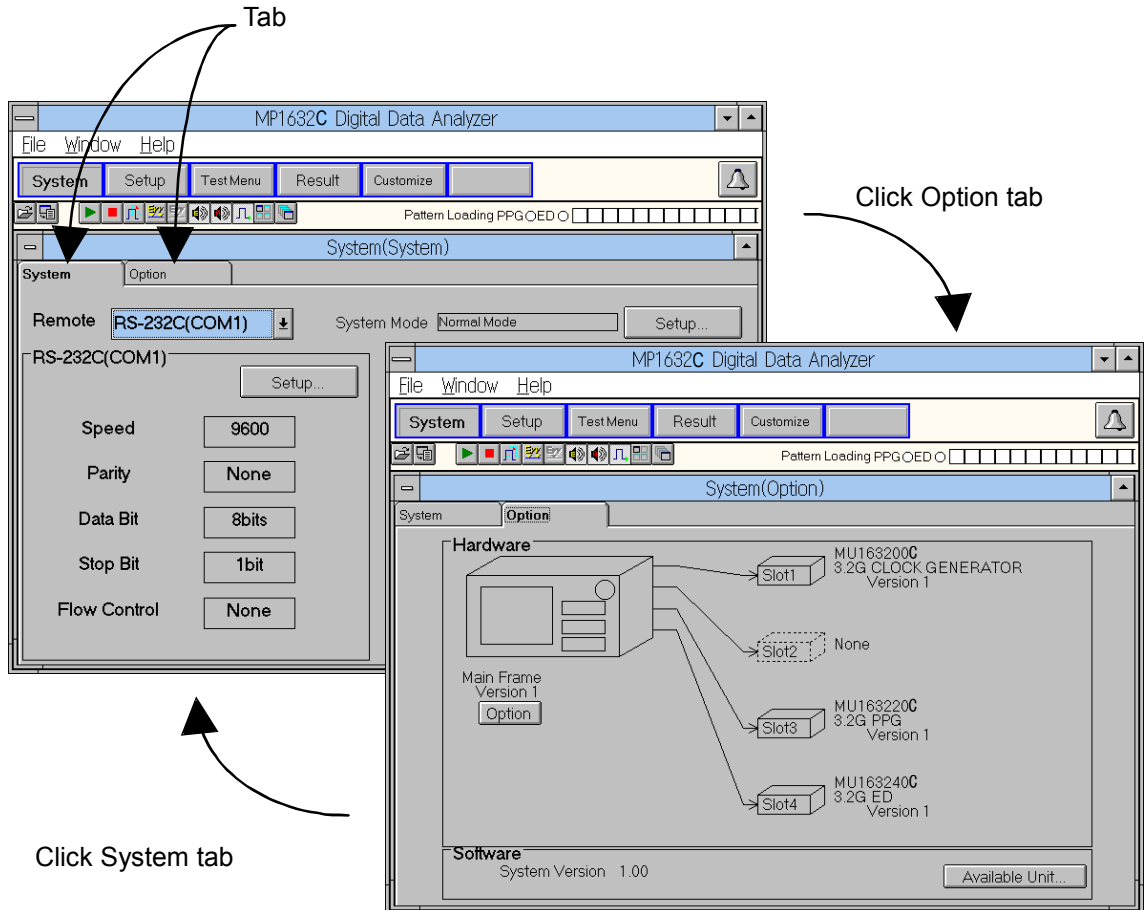

Fig. 5-8 Switching Panels

- To display a hidden panel
To display a panel hidden behind an open panel, click the tab of the panel to display. The panel thus selected will open.

5.4 Basic Setup Procedures

With the instrument, settings are normally changed by opening dialog boxes. (Some settings are changed on panels.) This section describes how to change instrument settings via dialog boxes.

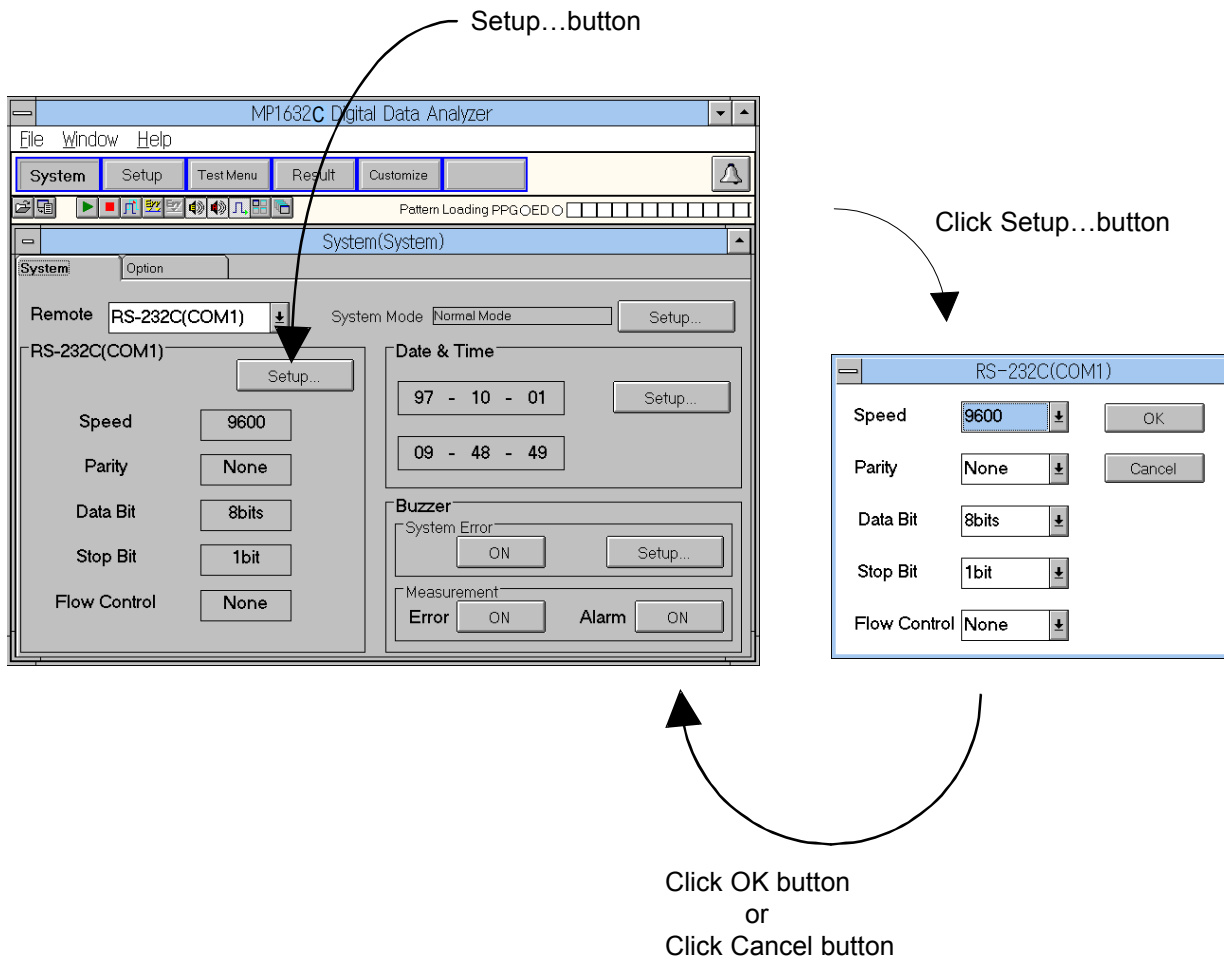

Fig. 5-9 Basic Setup Procedures

1. Click the Setup button associated with the item to change. A setup change dialog box will open.
2. Change the setting in the resulting dialog box. Depending on the setup item, you may have to open another dialog box (such as Pattern Edit). At this point, the change to the setting is simply displayed and does not affect the operation of the instrument itself.
3. Click OK to close the dialog box. The change is accepted and the instrument begins functioning according to the change. To cancel the change entered in the dialog box and return to the original state, click the Cancel button when closing the dialog box.

5.5 Entering Data

With the instrument, the following methods are used to manipulate displays:

- **Mouse manipulations**
You can run the application for the instrument the same way as you do Windows® applications on a personal computer.
- **Touch screen manipulations**
The instrument's touch screen offers you an equivalent of the capability of the mouse. Touch it with the custom pen supplied or fingers.
- **Manipulations with front-panel keys and the rotary encoder**
You can do the same with the instrument front-panel keys and the rotary encoder as you do with Windows® applications on a personal computer. In this case, certain operational differences from keyboard manipulations exist due to the limited number of keys supported by the instrument.
- **Keyboard manipulation**
Connecting a keyboard to the instrument enables you to manipulate its applications using the keyboard.
- **Software keyboard manipulations**
The instrument supports a software keyboard as an application program running on Windows®. Even though a keyboard is not available, the software keyboard enables you to enter characters. For instructions on how to use the software keyboard, see section 5.6 “Using Software Keyboard”.

Procedures for entering data are described below, along with operational differences, with primary regard to the usage of the front-panel keys and the rotary encoder.

Moving from one control to the next in a window

Where multiple controls exist in a single window, you can move the focus from one control to the next in the following ways:

- [Tab] key
Moves the focus from the control placed at the upper left corner of the window to the right.
- [Shift] + [Tab] key
Moves the focus in the direction opposite to the [Tab] key.

Manipulating windows

You can use panel keys to resize, move, and otherwise manipulate windows.

1. Click the control box in the window to manipulate, to open the control menu.
2. Using the [↑] and [↓], and [Enter] keys, select the window manipulation function to execute from the control box.
3. Manipulate the window with [↑], [↓], [→], and [←] to suit the function selected.
4. Press the [Enter] key to accept the change to the window.

Note

You can also open a control box by pressing [Shift] + [-].

Entering data with spin boxes

You can use spin boxes and the rotary encoder to enter numeric values.

1. Move the focus to the spin box to manipulate. When the spin box becomes the focus, a digit of the numeric value is highlighted.
2. Select the digit to change by moving the highlighted cursor, in either of the following ways:
 - [Press the [←] and [→] keys (on the rotary encoder).
 - Click the digit.
3. Change the numeric value. You can change the numeric value continuously with respect to the digit at the highlighted cursor in one of the following ways:
 - Click the spin button.
 - Turn the rotary encoder.
 - Press the [↑] and [↓] keys (on the rotary encoder).
4. You can also enter a numeric value directly with numeric keys. In this case, the current setting on display is entirely cleared regardless of the highlighted cursor position. The display is cleared entirely if you press the [BS] key before accepting the input data.
5. When you have changed a numeric value directly with numeric keys, press the unit key or the [Enter] key to accept the input data. The setting will be canceled when you do one of the following before pressing the unit key or the [Enter] key to accept the input:
 - Move the focus to another control.
 - Close the dialog box.
 - Move to another application.

Note

When a spin box is on a panel (in the Customize subwindow), you need to enable spin box entry by clicking the text entry enable button before changing the numeric value. The pilot lamp is on while the entry is enabled.

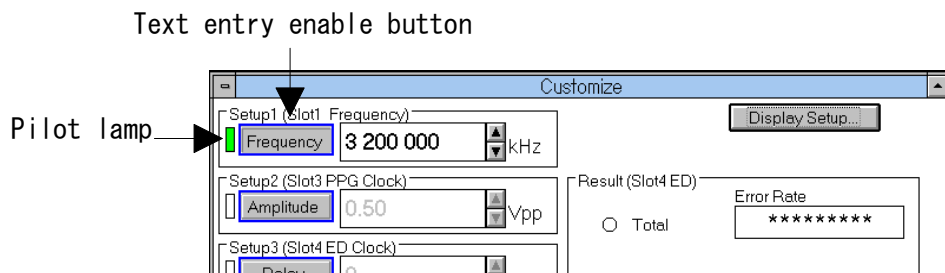

Fig. 5-10 Spin Box on a Panel

Using controls

To manipulate controls with panel keys, follow these steps.

- **Command button manipulations**

1. Move the focus to the command button.
2. Press the [Enter] key. The function associated with the button is executed.

- **Drop-down list boxes**

1. Move the focus to the drop-down list box to be altered.
2. Press the [Shift] + [Enter] keys. A list will open.
3. Select a list option by pressing the [↑], [↓], [→], and [←] keys on the rotary encoder.
4. Press the [Enter] key to close the list and accept the input data.

- **List boxes**

1. Move the focus to the list box to be altered.
2. Move the focus to the desired option by pressing the [↑], [↓], [→], and [←] keys on the rotary encoder.
3. Press the [Shift] + [Enter] keys to toggle between the selected and not selected states.

- **Option buttons.**

1. Move the focus to the group box to be altered.
2. Move the focus by pressing [↑], [↓], [→], and [←]. The option button of the item at the focus will turn on.

- **Check boxes**

1. Move the focus to the group box containing the check box to be altered.
2. Move the focus to the desired option by pressing [↑], [↓], [→], and [←].
3. Press the [Shift] + [Enter] keys to toggle between the selected and not selected states.

5.6 Using Software Keyboard

5.6.1 Character Input

The front panel of the instrument provides only the strict minimum of keys for numerical input. Therefore, a software keyboard is provided as an auxiliary function for character input. The software keyboard allows character input even when no keyboard is connected to the instrument.

The following example describes how to use the software keyboard to input a file name in the Save dialog box.

1. Click the `virkey.icon` in the [MP1632C] group in Program Manager. This starts the software keyboard.
2. Execute [File]-[Save] from the parent window to open the Save dialog box.
3. Click the text box where you want to input characters (in this case, the File Name text box), and click keys on the software keyboard. The characters you click are input in the text box.

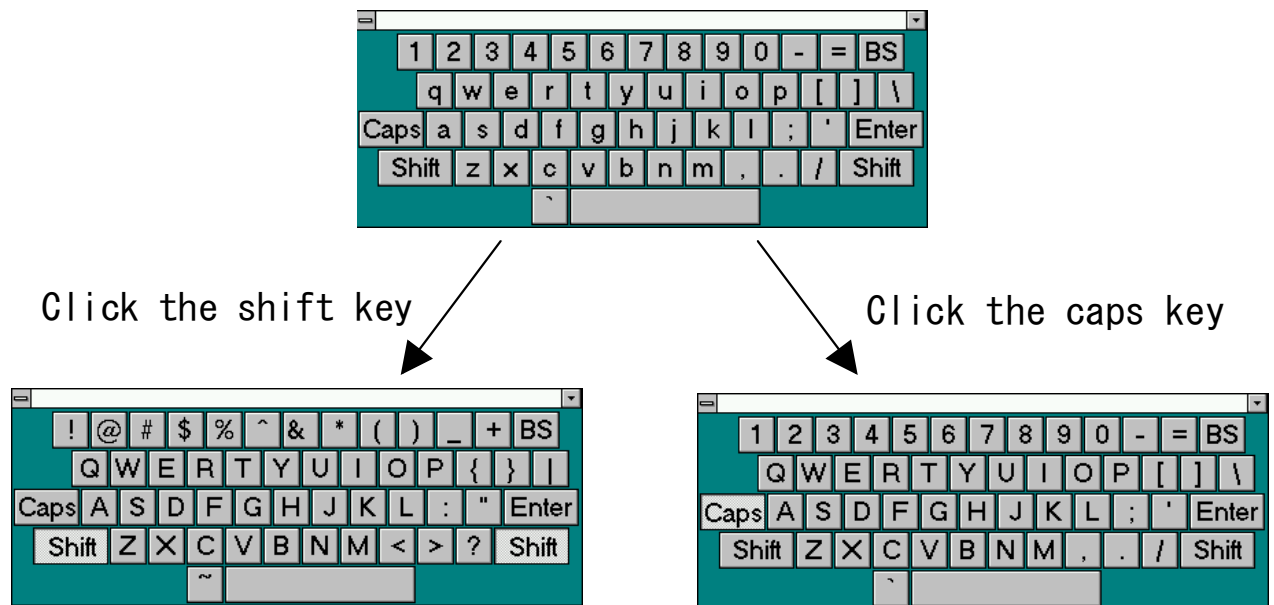

Fig. 5-11 Software Keyboard

4. To close the software keyboard, open the control box at the top left of the software keyboard, and select [Exit].

Note

The software keyboard performs character input to the control that is currently selected (controls for which text input is enabled, such as text boxes and spin boxes). In addition to the File Name text box used in the above example, numerical input can also be performed in controls such as spin boxes and the Windows® Notepad.

5.6.2 Setting the software keyboard

The size and display format of the software keyboard provided with the instrument can be changed to suit each usage condition.

- Changing the size

Click the button at the top left of the software keyboard to open the control box. Click the Size in the menu, and select a size among SS, S, M, L, and LL. A check mark will appear next to the selected size.

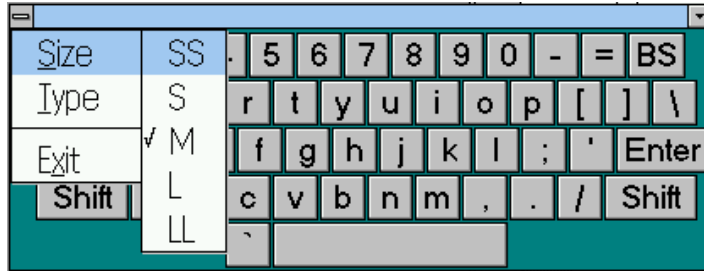

Fig. 5-12 Changing size

- Changing the display format

Click the button at the top left of the software keyboard to open the control box. Click the Type in the menu and select one among Full-Key, 10-Key, and 16-Key. A check mark will appear next to the selected format.

Full-Key All keys can be used.

10-Key Only numerical keys can be used.

16-Key Only numerical keys and character keys (A to F) can be used.

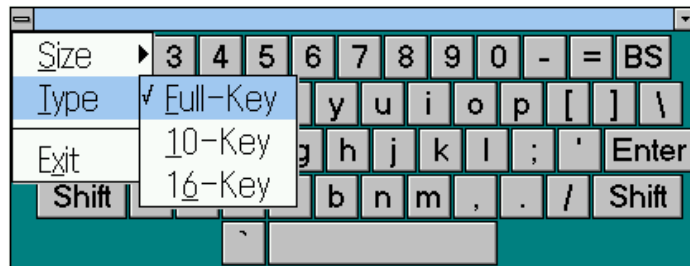

Fig. 5-13 Changing display format

- Changing the background color

Click the button at the top left of the software keyboard to open the control box. Click Color in the menu and select your favorite color among background displayed.



Fig. 5-14 Changing the background color

- Saving setup data

Click the button at the top left of the software keyboard to open the control box. When click Save in the menu, current setup data is saved.



Fig. 5-15 Saving setup data

(Blank)

CHAPTER 6 OPERATING INSTRUCTIONS

6.1 Touch Screen Calibration

The instrument allows you to carry out display operations via the touch screen. The touch screen requires preliminary adjustment to ensure that the location of the display surface touched will be correctly transmitted to the software. To adjust the touch screen, follow these steps:

1. Double-click the TTSetup3.20 icon in the program manager Main group. The touch screen setup application will start running.
2. Run [Calibrate] from the touch screen setup application menu bar. Calibrate the touch screen as directed by the screen guidance.
3. Calibration is now complete. Select [Exit] from the menu bar. The touch screen setup application will terminate.

Note

Do not execute any touch screen setup application other than [Calibrate]. Successful functioning of the touch screen could be disabled if its setting is altered by executing such other functions.

6.2 Saving and Opening Setup Data

6.2.1 Saving setup data

With the instrument, you can save setup data to floppy disks or hard disk. There are two ways to save setup data as follows:

- **Quick Save**
This function saves multiple records of data, such as instrument setup data and unit-specific set-up data, all at once. It is used to save the complete set of data at once by viewing it as an integrated environment for the instrument.
- **Save**
This function saves multiple records of data, such as instrument setup data and unit-specific set-up data, one at a time. It is used to save selected records of data.

Note

While the instrument supports two hard disk drives C and D, drive D is dedicated to virtual memory and is not accessible to users. Drive C would not be available for saving data, either, when system operations have been set in the measurement power fail mode. For more details on system operations, see section 6.4 "Setting System Operations".

Quick Save procedure

1. Select [File]-[Quick Save] from the parent window menu bar. The Quick Save dialog box will open.

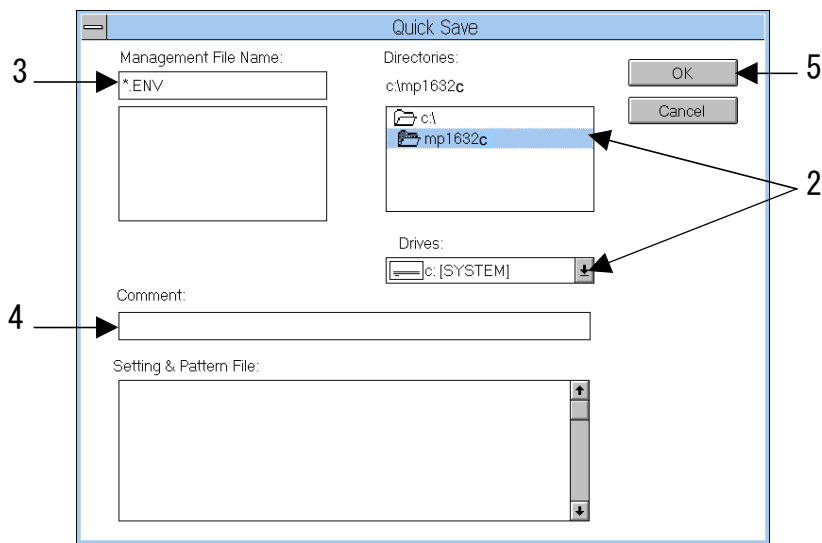

Fig. 6-1 Quick Save Dialog box

2. Using the Directories and Drives controls, select the directory and drive in which to save an environmental file.
3. Type the filename of the environmental file to save in the Management File Name text box with seven or fewer characters.

Note

Environmental filenames may not be longer than seven characters. Inconveniences might result if this length limit is exceeded.

4. You can type a comment of up to 60 characters in the Comment text box to document the environment saved. A character string giving a summarized description of the environment is recommended as a comment to facilitate ready verification of the data.
5. The setup procedure is now complete. Click OK to save the data. The environmental file thus saved is given the extension .ENV.

Note

This function creates various data files (with extensions, such as .FRM, .CLK, and .PPG) at the same time as it creates a single environmental file (.ENV). The filenames of these data files are the filename of the environmental file with its extension changed to suit the kind of data. They are created in the same directory as the environmental file. The files that are created concurrently with the environmental file are listed in the Setting & Pattern File: list.

Save procedure

1. Select [File]-[Save] from the parent window menu bar. The Save dialog box will open.

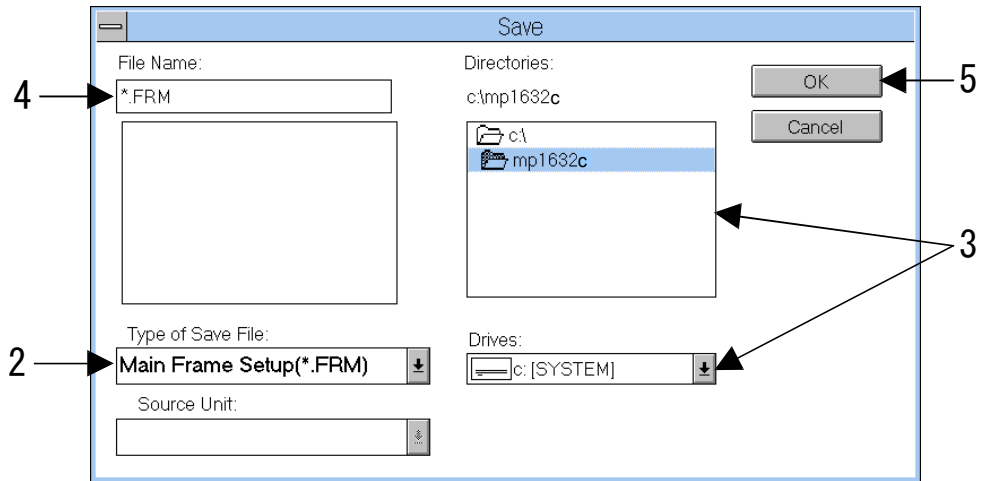

Fig. 6-2 Save Dialog Box

2. Select the type of file to save from the Type of Save File drop-down list box.

Main Frame Setup(*.FRM)	Saves instrument (main frame) setup data.
Slot1 Setup(*.CLK)	Saves 3.2G internal synthesizer (OPT03) setup data

3. Using the Directories and Drives controls, select the directory and drive in which to save a file.
4. Type the filename of the file to save in the File Name text box with eight or fewer characters.
5. The setup procedure is now complete. Click OK to save the data. The file thus saved is given the extension .FRM or .CLK.

6.2.2 Opening setup data

With the instrument, you can open setup data or measurement data from floppy disks or hard disk. There are two ways to open setup data as follows:

- **Quick Open**
This function opens multiple records of data, such as instrument setup data and unit-specific setup data, all at once. It is used to open the complete set of data at once by viewing it as an integrated environment for the instrument.
- **Open**
This function opens multiple records of data, such as instrument setup data and unit-specific setup data, one at a time. It is used to open selected records of data.

Note

While the instrument supports two hard disk drives C and D, drive D is dedicated to virtual memory and is not accessible to users. Drive C is available for opening data at all times.

Quick Open procedure

1. Select [File]-[Quick Open] from the parent window menu bar. The Quick Open dialog box will open.

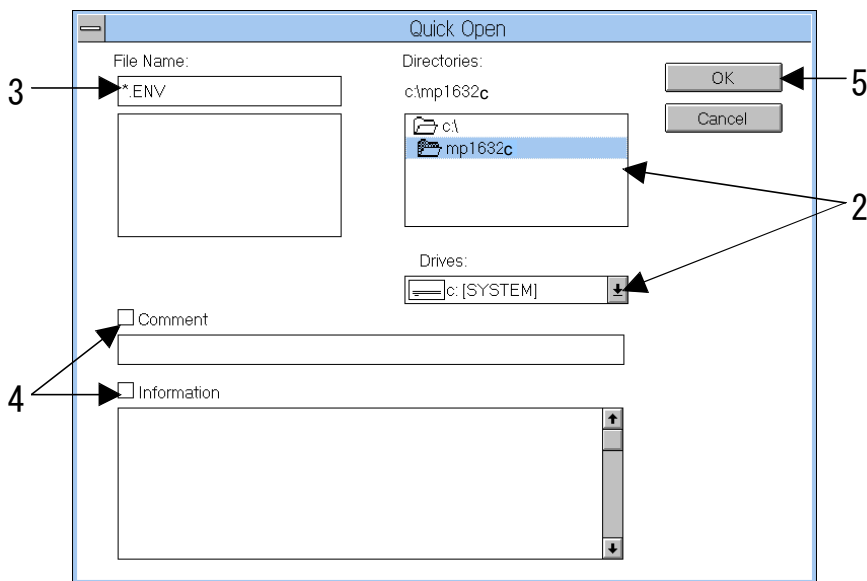

Fig. 6-3 Quick Open Dialog Box

2. Using the Directories and Drives controls, select the directory and drive in which the environmental file to open is stored.
3. Select the filename of the environmental file to open from the File Name list box.

4. You may check the Comment check box to read the comment on the environmental file selected, or check the Information check box to view the filenames of the various files managed by the environmental file created.
5. The setup procedure is now complete. Click OK to open the data.

Open procedure

1. Select [File]-[Open] from the parent window menu bar. The Open dialog box will open.

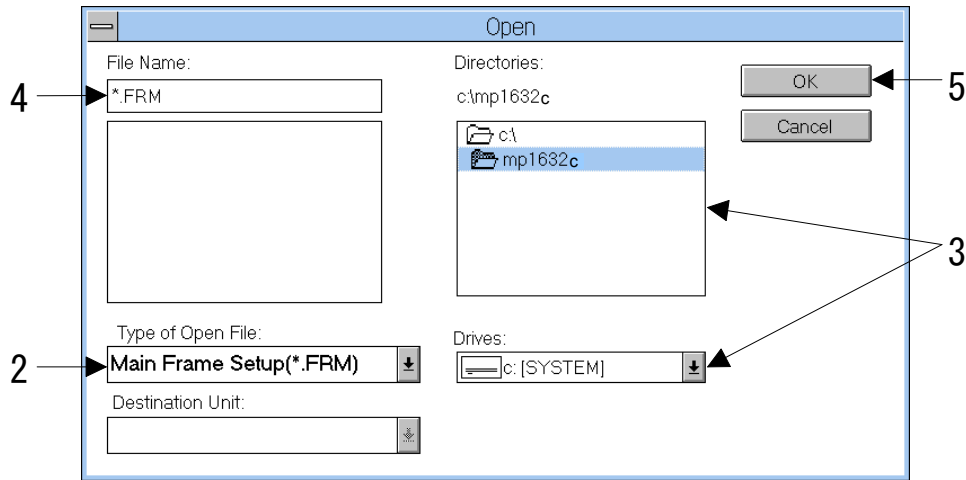

Fig. 6-4 Open Dialog Box

2. Select the type of file to open from the Type of Open File drop-down list box.

Mainframe Setup(*.FRM)	Reads instrument (mainframe) setup data.
------------------------	--

Slot1 Setup(*.CLK)	Reads 3.2G internal synthesizer (OPT03) setup data.
--------------------	---

3. Using the Directories and Drives controls, select the directory and drive in which the file to open is stored.
4. Select the filename of the file to open from the File Name list box.
5. The setup procedure is now complete. Click OK to open the data.

6.2.3 Manipulating files

Data written to floppy disks or hard disk can be manipulated from the file manager. The file manager provides functions for deleting, moving, copying, and otherwise manipulating files. For more detailed procedural information, see the help files for file manager.

Note

1. You may change filenames with the file manager, but not the extensions. Files could become inaccessible for opening if their extensions are altered.
 2. Files managed in the environmental file (one specified at Quick Open/Quick Save) could become inaccessible for opening at Quick Open if their filenames are altered.
 3. To provide against possible damage to the hard disks, periodic backups of the stored data are recommended.
-
-

6.3 Choosing Remote Control

6.3.1 Choosing remote control interfaces

The instrument supports RS-232C, and GPIB (option), ETHERNET(option) as remote control interfaces. Setup procedures for using these interfaces are described below.

1. Open the 'System:System' panel.

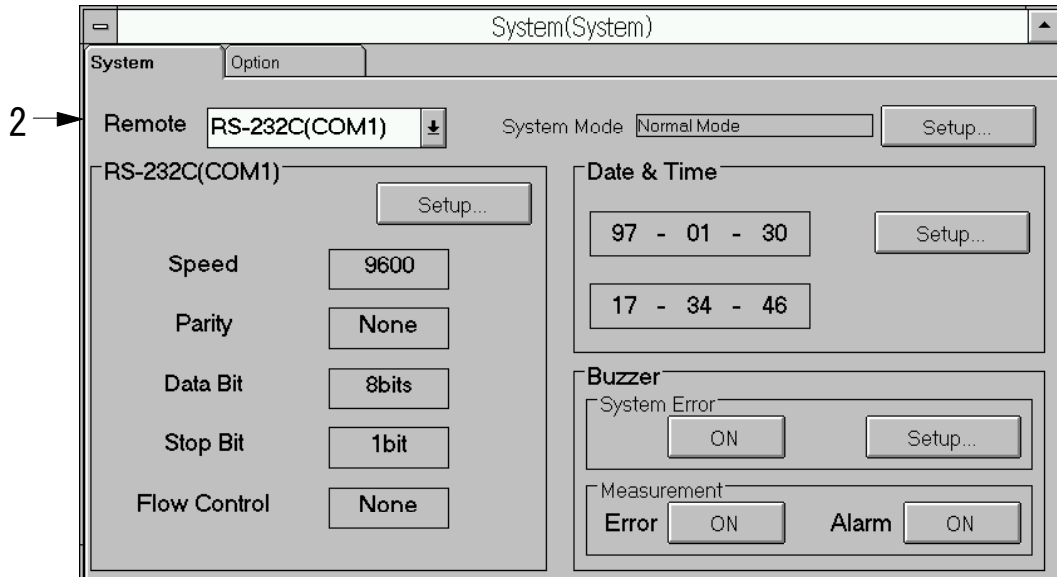

Fig. 6-5 System:System Panel

2. Select the type of interface to use from the Remote drop-down list box.

RS-232C(COM1)	Selects the RS-232C remote control interface.
GPIB	Selects the GPIB remote control interface, only if OPT-01 (GPIB option) has been installed.
ETHERNET	Selects the ETHERNET remote control interface, only if OPT-02 (ETHERNET option) has been installed.
None	Does not use a remote control interface.

3. The setup procedure for using a remote control interface is now complete. For more interface details refer to the subsections that follow.

6.3.2 Setting RS-232C

Procedures for selecting the RS-232C remote control interface are described below.

1. Select RS-232C (COM1) from the Remote drop-down list, and the RS-232C (COM1) group box will open on the 'System:System' panel.
2. Click the Setup button in the group box. The RS-232C (COM1) dialog box will open.

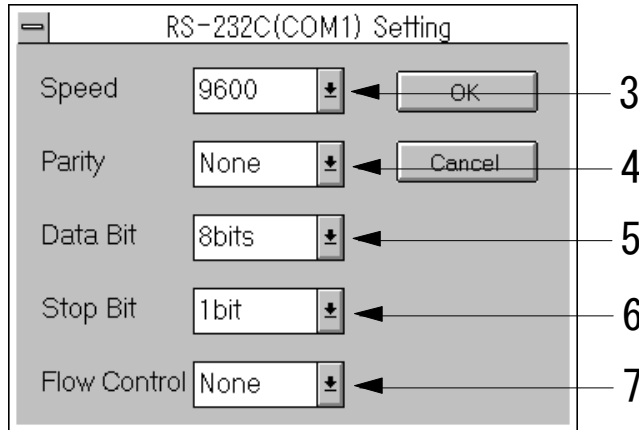

Fig. 6-6 RS-232C(COM1) Dialog Box

3. Set the transmission speed by selecting it from the Speed drop-down list box.

110	Sets 110 bps.
300	Sets 300 bps
600	Sets 600 bps.
1200	Sets 1200 bps.
2400	Sets 2400 bps.
4800	Sets 4800 bps.
9600	Sets 9600 bps.
19200	Sets 19,200 bps

4. Set the kind of parity by selecting it from the Parity drop-down list box.

None	None
Even	Even parity
Odd	Odd parity

5. Set the transmission character length in bits by selecting it from the Data Bit drop-down list box.

8bits	Sets 8 bits.
7bits	Sets 7 bits.

6. Set the stop bit length by selecting it from the Stop Bit drop-down list box.

2bits	Sets 2 bits.
1bit	Sets 1 bit.

7. Sets the method of flow control by selecting it from the Flow Control drop-down list box.

Xon/Xoff	Implements flow control using the Xon/Xoff characters, in addition to the RS-232C control line.
Hardware	Implements flow control using the RS-232C control line.
None	Do not implement flow control.

8. The RS-232C setup procedure is now complete. Click OK to enable the settings.

6.3.3 Setting GPIB

Procedures for selecting the GPIB remote control interface are described below.

1. Select GPIB from the Remote drop-down list, and the GPIB group box will open on the 'System: System' panel.
2. Click the Setup button in the group box. The GPIB dialog box will open.

When using SCPI commands, select SCIP from Command Type option switch. In this case, GPIB Address must be within 1 to 30.

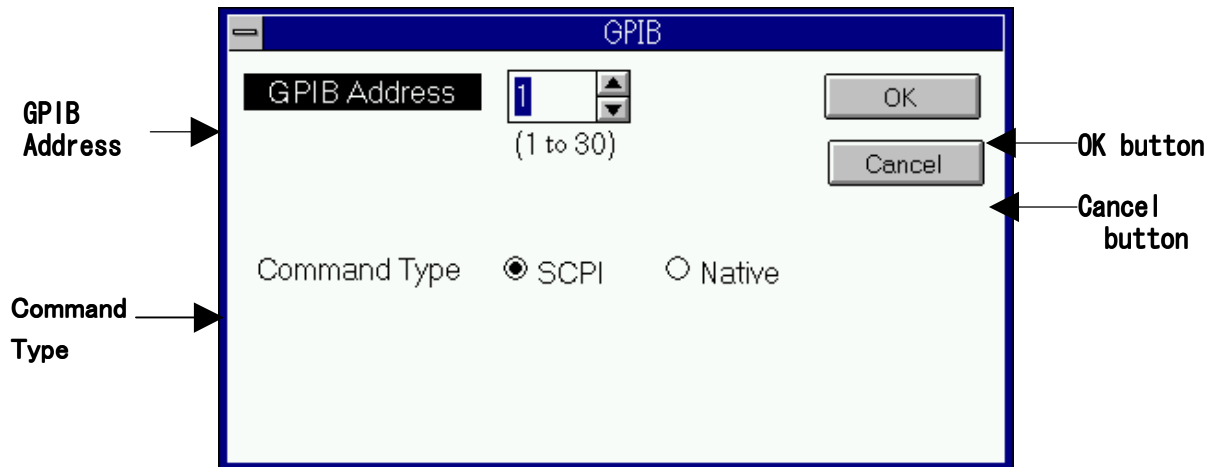

Fig. 6-7 GPIB Dialog Box (SCIP)

3. When using Native commands, select Native from Command Type option switch. In this case, GPIB Address (Address1) must be within 2 to 28. The Address2 must be next value of Address1. It will be set to such value automatically. And, select to which unit is assigned each addresses.

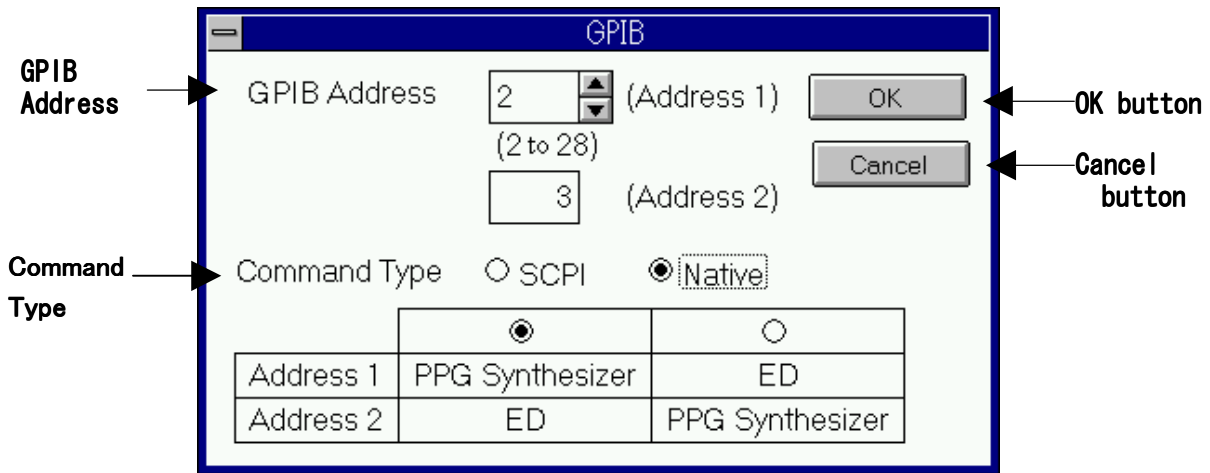

Fig. 6-8 GPIB Dialog Box (Native)

4. Now, the GPIB settings are completed. To enable the settings, click the OK button. To disable the settings and return the parameters to the original values, click the Cancel button.

Changing the command type will cause rebooting Windows. To enable setting above, press OK button on the attempt dialog box displayed after closing the GPIB dialog box.

6.3.4 Setting ETHERNET

There is no setup items, when you use Ethernet as remote control interface. For descriptions of Ethernet, refer to the Ethernet Option operation manual.

6.4 Setting System Operations

The instrument can be toggled between the system mode in which power failure measurement is enabled or not.

1. Open the 'System:System' panel.

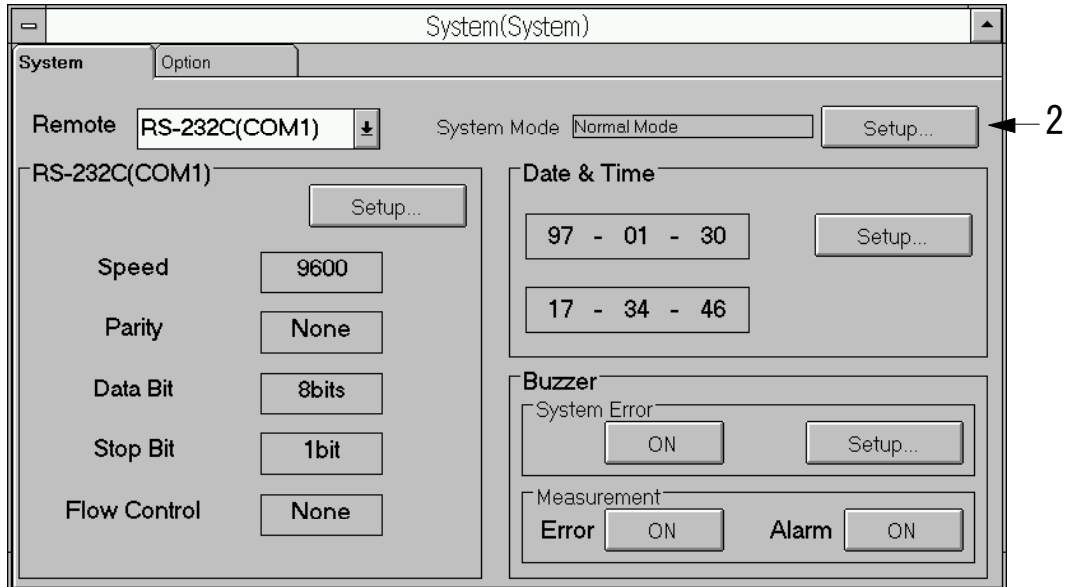

Fig. 6-9 System:System Panel

2. Click the Setup button next to the System Mode label in the System panel. The System Mode dialog box will open.

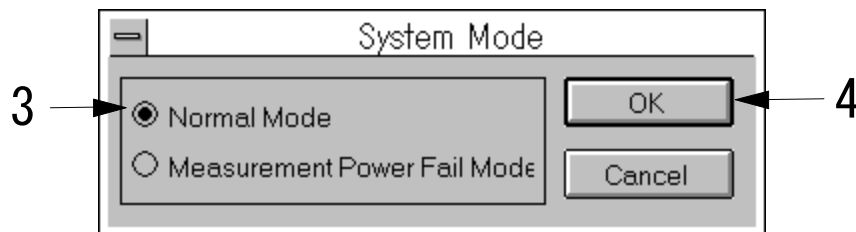

Fig. 6-10 System Mode Dialog Box

3. Set the system operation by selecting it with an option button.

Normal Mode	Puts the system into the mode in which power failure measurement is disabled.
Measurement Power Fail Mode	Puts the system into the mode in which power failure measurement is enabled.

Note

In these modes the following functions are operable or inoperable:

Function	Normal Mode	Measurement Power Fail Mode
Power failure measurement	×	○
Data saving to hard disk	○	×
PRGM pattern editing/printing with the pattern editor	○	×

○ : Operable × : Inoperable

4. The setup procedure is now complete. Click OK button to enable the setting.

Note

An alteration to this setting in turn alters the setting of Microsoft® Windows® Operating System, requiring it to be rebooted. A warning message appears before the system is rebooted.

CAUTION 

1. The application may access the hard disk to run when the instrument is in the normal mode. Damage to the hard disk might result, therefore, if the application is stopped without following the regular shutdown procedure, as by turning off the front-panel power switch. To protect the hard disk, follow the routines suggested in section 4.1 “Starting and Stopping the MP1632C” to stop the instrument in the normal mode.
 2. In an unstable power environment prone to power failures, you should use the instrument in the power fail mode to safeguard the hard disk.
-

6.5 Setting Date and Time

This section describes how to set the date and time for the instrument.

1. Open the 'System:System' panel.

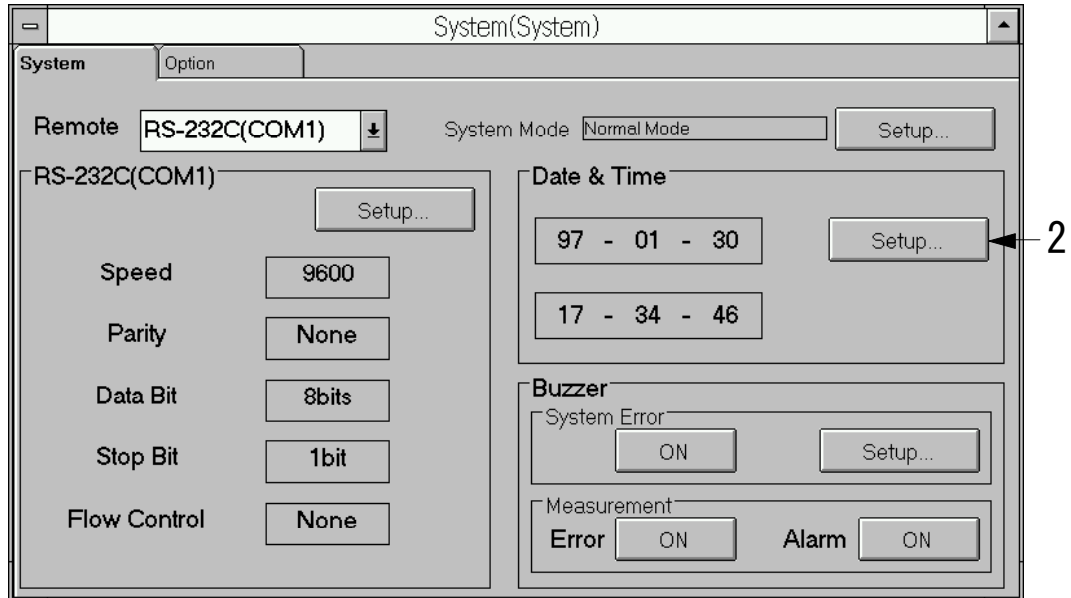

Fig. 6-11 System:System Panel

2. Press the Setup button in the Date & Time group box. The Date & Time dialog box will open.

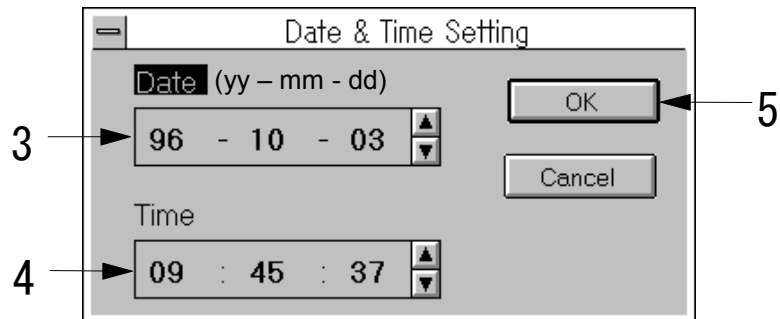

Fig. 6-12 Date & Time Dialog Box

3. Set the date by entering into the Date spin box. The date will appear in year-month-day format.

0 to 99:Step 1:	Sets the lower two digits of the year between 1996 and 2037.
1 to 12:Step 1:	Sets from January to December.
1 to 31:Step 1:	Sets the first to 31st.

4. Set the time by entering into the Time spin box. The time will appear in hour-minute-second format.

0 to 23:Step 1:	Sets from 0 to 23 hours.
0 to 59:Step 1:	Sets from 0 to 59 minutes.
0 to 59:Step 1:	Sets from 0 to 59 seconds.

5. The setup procedure is now complete. Press the OK button to enable the settings.

Note

The instrument has an IC to manage the measurement reference time. The instrument, when started up, makes the time data retained by the IC meaningful to the application and hardware.

You can set the date and time by using the Windows® functions even while the instrument control application is not running, but the date and time thus set would not be reflected in the time management IC in the instrument. Consequently, two different records of time data would result, the time data altered with Windows® and the time data retained by the time management IC.

If the instrument is started in this condition, the time data retained by the IC would take effect, with the result of the date and time altered with Windows® being reset to their pre-alteration status (date and time retained by the IC).

To avoid this inconvenience, you should use the application's 'System:System' panel to make alterations to the date and time.

6.6 Setting Buzzer

This section describes how to set the ON or OFF of buzzer for the instrument.

1. Open the 'System:System' panel.

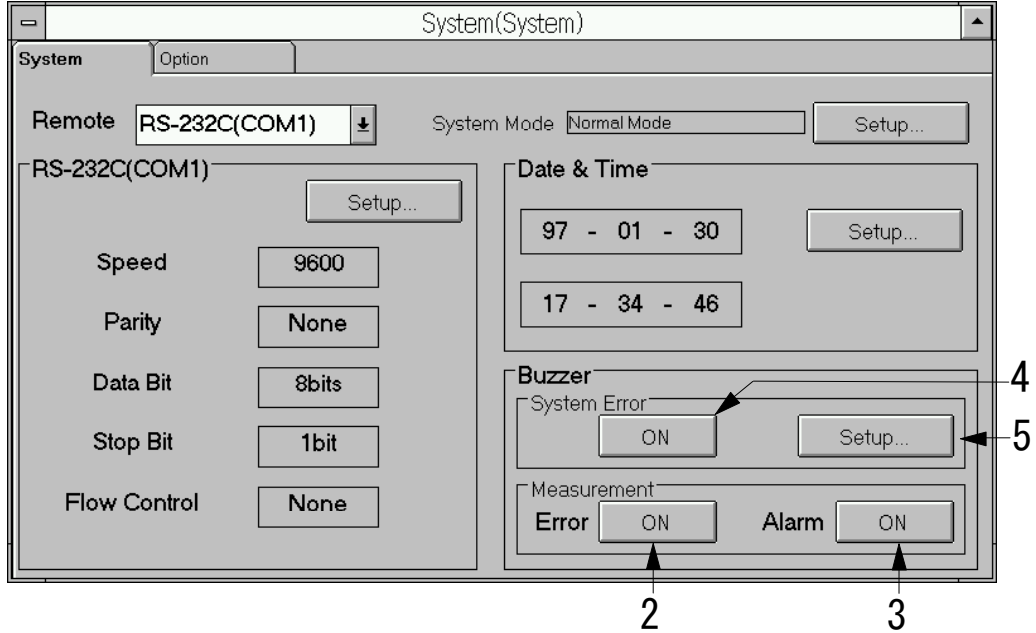

Fig. 6-13 System:System Panel

2. To switch error buzzer, press the Error button. Its On/OFF status changes as often as the Error button is pressed.
3. To switch alarm buzzer, press the Alarm button. Its On/OFF status changes as often as the Alarm button is pressed.
4. To switch system error buzzer, press the button specified by the arrow. Its On/OFF status changes as often as the button is pressed.
5. For the system error buzzer you can select valid type of system error. Press the Setup button, and the System Error Buzzer dialog box will open.

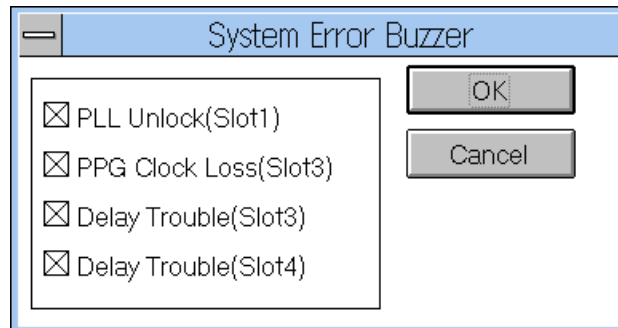

Fig. 6-14 System Error Buzzer Dialog Box

6. Select the type of desired system error by pressing the corresponding check box. Checked system error becomes valid. Press the OK button to enable the settings.

Description of each system error is below.

(PLL Unlock)

The PLL circuit in the internal synthesizer option unlocked.

(PPG Clock Loss)

The Clock Input connector on the rear panel of the PPG unit is not connected normally.

(Delay Trouble(slot3))

The clock delay module of the PPG unit is out of order.

(Delay Trouble(slot4))

The clock delay module of the ED unit is out of order.

6.7 Checking Occurred System Error

When a system error occurs a bell-button appears at upper right corner of the parent window.

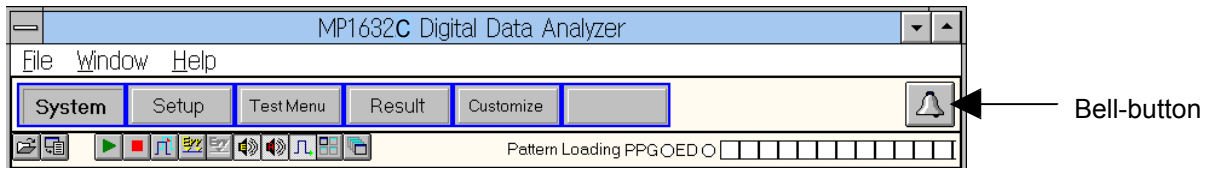

Fig. 6-15 Bell Button

Clicking this button opens a dialog box where the type of occurred system error is displayed.

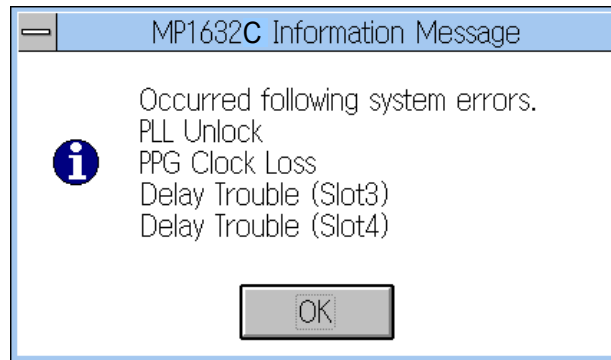

Fig. 6-16 Dialog Box displaying System errors

6.8 Viewing the Configuration of Units Inserted in the MP1632C

'System:Option' panel lets you view the hardware system configuration and the software configuration of the instrument. It displays the following kinds of information:

- Hardware system configuration
 - Kinds of units inserted in slots 1 to 4
 - Availability of options for each unit
 - Availability of options for the mainframe
- Software configuration
 - Software version number
 - Units and options that can be controlled by current software version

1. Open the 'System:Option' panel.

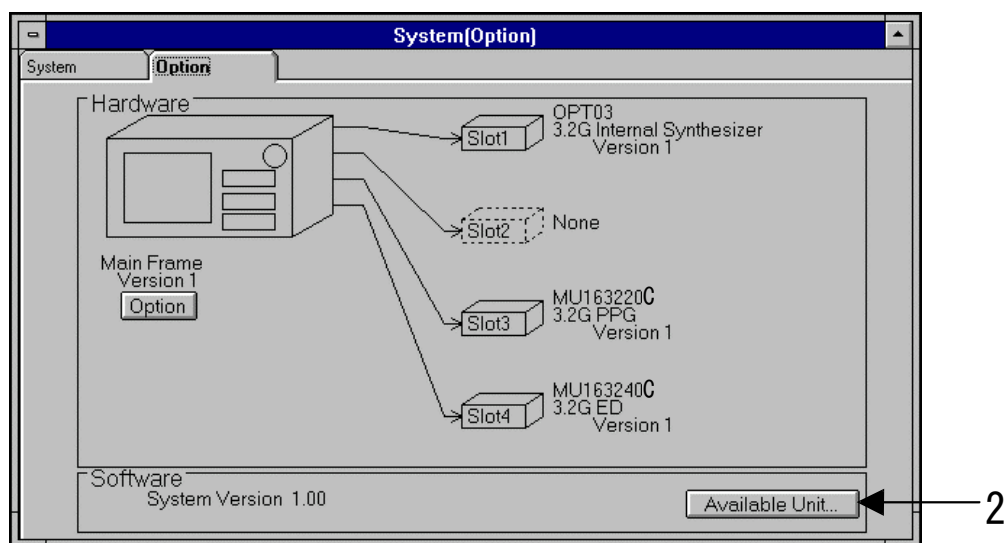

Fig. 6-17 System:Option Panel

2. The hardware system configuration and the software configuration of the instrument are displayed.

A dotted box means that the slot is empty or any other instruments current version of the software can control, is inserted the slot.

Click the Available Unit button in the Software group box, and the Available Unit dialog box opens, giving you a look at the units and options that an be controlled with the present control application. Click OK to close this dialog box.

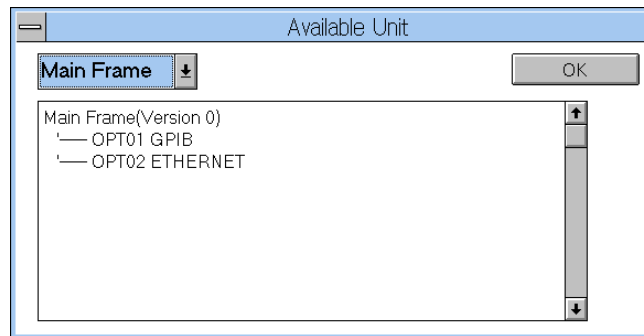

Fig. 6-18 Available Unit Dialog Box

3. Click the Option button for the mainframe or units and a drop-down list opens under the button, showing a list of options installed.

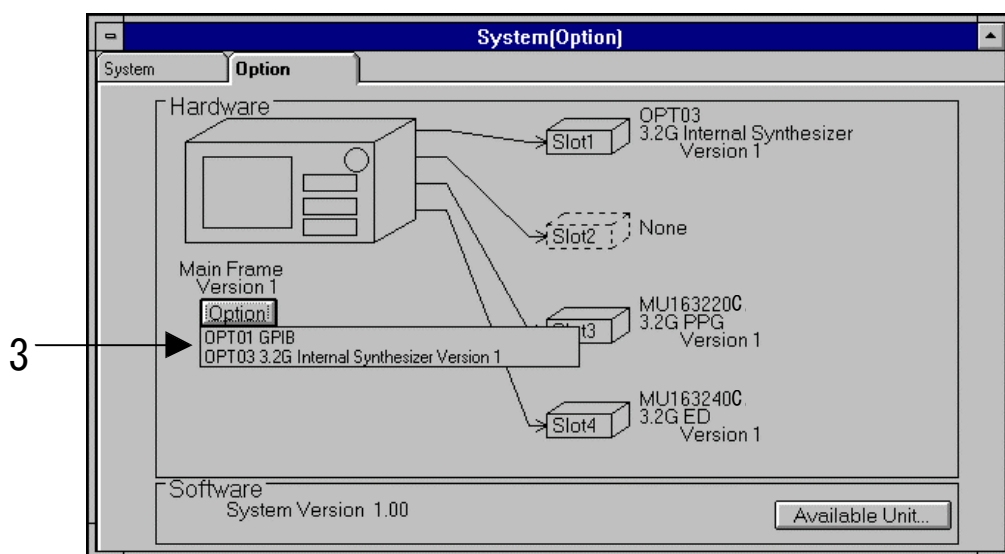

Fig. 6-19 Option Drop-down List

6.9 Printing Out Display Images

The instrument permits hard-copying display images to a printer.

1. Before carrying out a hard-copy operation, you need to set up the printer. Select [File]-[Printer Setup] from the parent window menu bar. The Printer Setup dialog box will open.

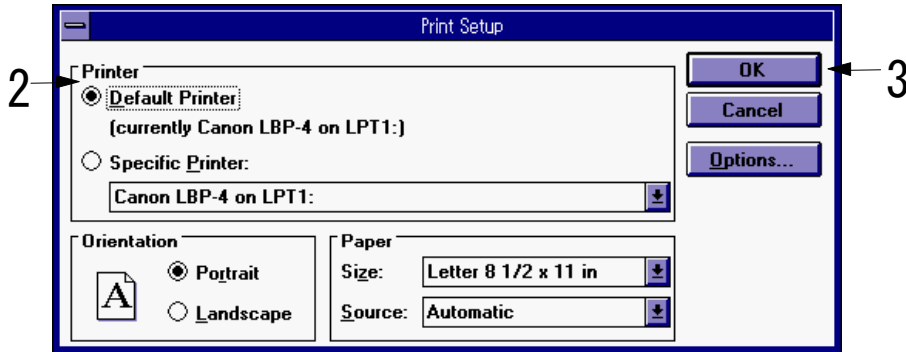

Fig. 6-20 Printer Setup Dialog Box

2. Set up the printer to suit the kind of printer connected to the instrument.
3. When the setup procedure is complete, click OK to enable the setting.
4. Open the display image to hard-copy. Select [File]-[Hard Copy] from the parent window menu bar. The display image will be hard-copied to the printer connected.

Note

Make sure that printer setting is suitable. For details refer "3.2.2 Connecting peripherals".

6.10 Resetting to Factory Defaults

The instrument can be reset to its factory defaults by initializing its setup status and measurement data.

1. Select [File]-[Initialize] from the parent window menu bar.
2. The instrument is reset to its factory defaults. Before initialization begins, a warning message is displayed asking if you really want to initialize the instrument or cancel the initialization.

Note

This function initializes the setup status and measurement data in the instrument, but not its remote control settings. For the factory defaults of the individual functions see Appendix A, "Display-specific Setup Items."

6.11 Recovering Software

The instrument is controlled by Microsoft® MS-DOS® Operating System, Microsoft® Windows® Operating System, and other applications. The instrument may fail to work correctly if any part of the software is corrupted by HDD fails or invalid file manipulations.

If this happens, you need to carry out software recovery by using the recovery tool supplied with the instrument.

Note

1. All the data stored on the hard disk would be lost if software recovery is carried out. You should keep backup copies of the setup data stored on the hard disk beforehand.
 2. Do not run the recovery tool on any machine (such as a personal computer) other than the instrument. This act constitutes a violation of the software usage obligations.
-
-

Recovery tool configuration

The recovery tool is designed to recover the system software, and other applications. It provides the following two functions:

1. System software recovery(Attached Recovery DISK)
The recovery tool recovers the system software. It also makes the LEDs, rotary encoders, panel keys, touch panel, and software keyboard operable.
2. Application recovery(Attached Application DISK)
The recovery tool recovers the control application.

Recovery preparations

Complete the following preparations before beginning software recovery:

1. Connect an external keyboard to the instrument.
The execution of the recovery software requires an external keyboard to be connected to the keyboard. Connect a keyboard to the rear-panel keyboard connector.
2. Enable booting from the floppy disk at power-on time.
The instrument is normally programmed to boot software from the hard disk when it is turned on. To carry out recovery, it is necessary to insert the recovery disk into the floppy disk drive and then start the recovery tool from that disk. To enable booting from the floppy disk at power-on time, do the following:
 - [1] Turn on the power. When it beeps, press the S key (letter S) while holding down the Ctrl and Alt keys. The setup window will open.
 - [2] Point to the Quick Boot position on the screen. The current setting is Enabled (booting from the hard disk). Using the + and - keys, change it to Disabled (booting from the floppy disk).

Note

Do not change any setting other than Quick Boot. Turning off the power will reset the setup window to its initial status.

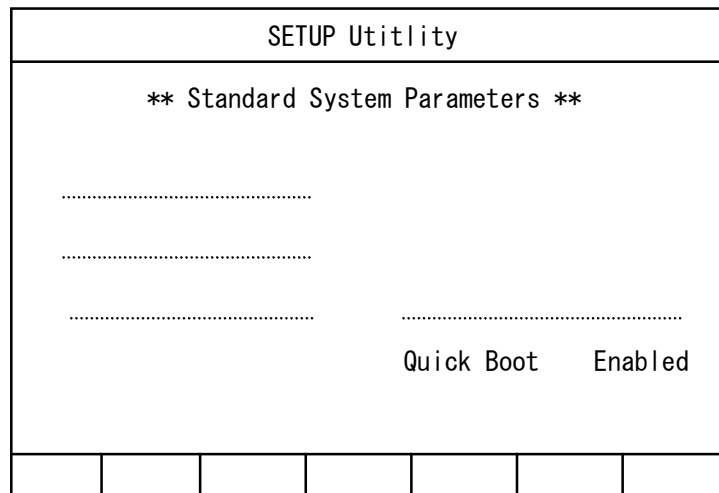

Fig. 6-21 Recovery Preparations

- [3] Insert the recovery disk DISK1 into the FDD.
- [4] Press the ESC key and then F4. The recovery tool starts from FD and recovery processing begins

Recovery procedures

The software recovery procedures are described below.

- System software recovery
1. After this system is ready for recovery, the recovery tool starts and the message below appears on the screen. When the message shown below appears, answer [Y] to proceed with recovery and partitioning. A reply of [N] will cancel recovery. For now, answer [Y].

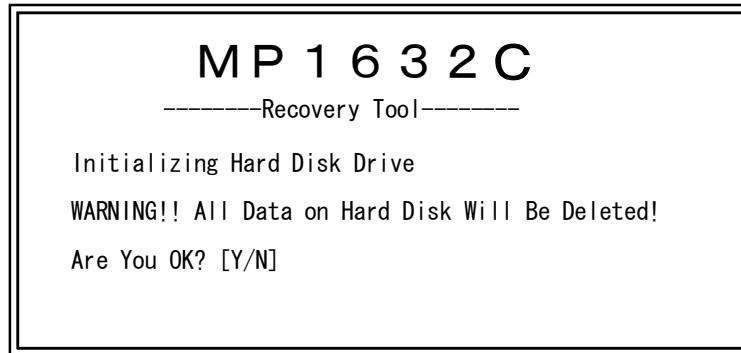

Fig. 6-22 User Confirmation Message

2. The message shown below indicates that partitioning is in progress. The system will be booted when the partitioning is complete.

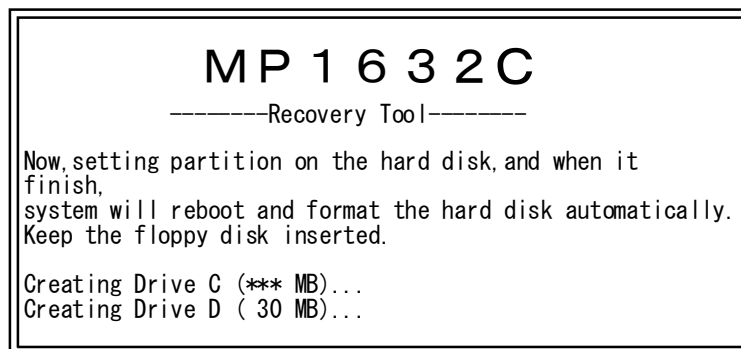

Fig. 6-23 Partitioning in Progress

3. When the system is booted, formatting of drives C and D begins. Before formatting starts, the message below appears on the screen to ask you if formatting is executed. In the instrument, however, [Y] is entered automatically and formatting begins.

4. When the formatting is finished, files are copied to the HD. Replace FDs according to the screen guidance.

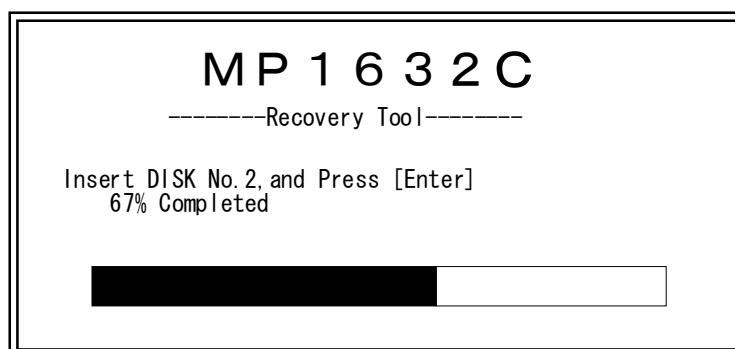

Fig. 6-24 Copying in Progress

5. The appearance of the message shown below signifies the completion of system software recovery. Remove the FD and press the [Enter] key. The system is rebooted and Windows® starts running.

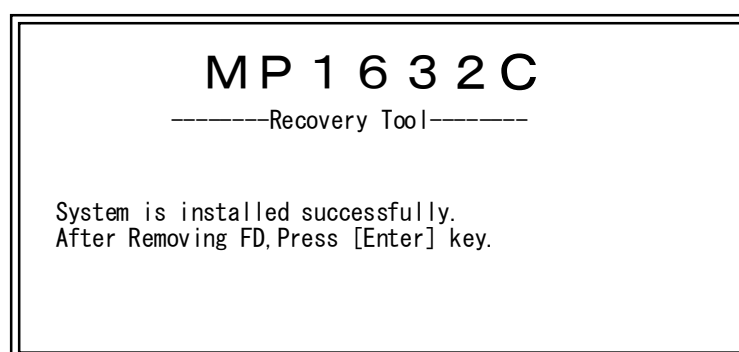

Fig. 6-25 Completion of OS Recovery

- Application recovery

To carry out application recovery, follow these steps:

1. Insert the application installer disk DISK1 into the FDD and select [File]-[Run] from the Windows program manager. Type "a:\¥setup" into the Command Line text box and click OK. Application recovery will begin. Replace FDs according to the screen guidance.
2. When the recovery is finished, an application icon (icon name: [MP1632C Digital Data Analyzer]) and MP1632C group are created icon in the program manager, and Windows® restarts.
3. The recovery of the system software and applications is now complete.

Messages displayed during recovery

The messages shown below may be displayed while recovery is in progress. Suggested responses are described below.

1. **"One or more Visual Basic applications are running. Please close those applications, then check OK to continue."**

This message is displayed when other application software is running.

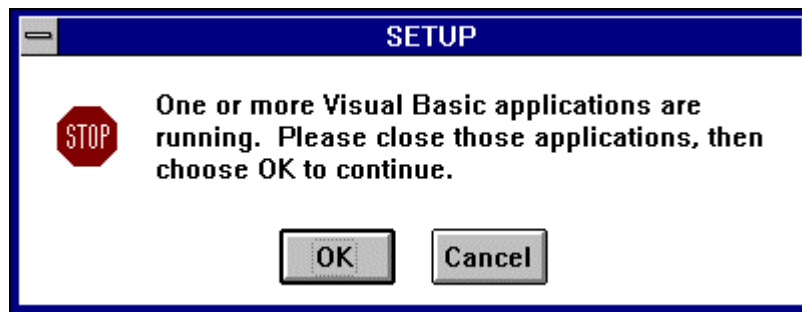

Fig. 6-26 Message Dialog Box (No.1)

When above dialog box appears, click OK after close other applications. Procedure closing those applications is described below.

- (1) To open the Task List dialog box, double-click on wallpaper (An area displayed no windows).

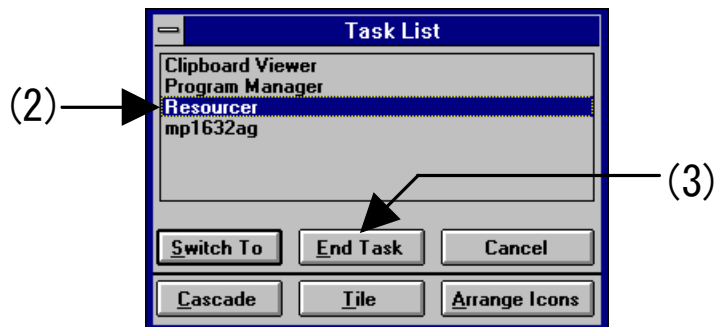

Fig. 6-27 Task List Dialog Box

- (2) To reverse application title you want to close, click the title string.
- (3) Press End Task.
- (4) Repeat (2) and (3), until all application without "Program Manger" and "SETUP" are closed.

2. **“Can not copy file A: \CTL3D.DL_ since the destination file is already in use”**

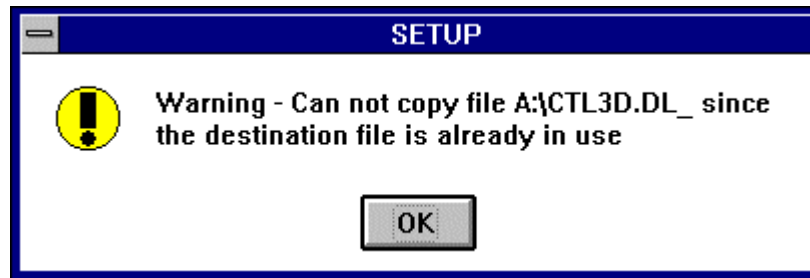

Fig. 6-28 Message Dialog Box (No.2)

There is no problem. Click OK.

3. **“MP1632C Application is already installed. Are you sure to overwrite?”**

This message is displayed when application software already exists on the hard disk (only application recovery has been carried out, without system software recovery). The system versions of the existing and installing applications are displayed in this dialog box. To display the detail of version information, push “Detail” button. Click Available Unit and the controllable units are listed. To continue recovery, click Yes; to cancel, click No.

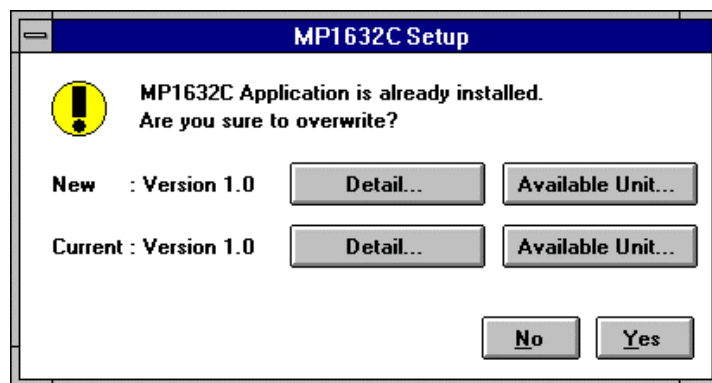

Fig. 6-29 Message Dialog Box (No.3)

4. **“MP1632C application is running”**

This message is displayed when the application is already running. To continue recovery, terminate the application first.

5. **"The Boot ROM version isn't compatible with this application"**

This message is displayed when the boot ROM (ROM required to effect instrument start-up) is newer than the version supported by the recovery tool. Click OK to cancel recovery. The recovery tool may be outdated.

6. **"The Main Frame version isn't compatible with this application"**

This message is displayed when the instrument hardware is newer than the version supported by the recovery tool. Click OK to cancel recovery. The recovery tool may be outdated.

6.12 Using the MP1632C Menu

When the instrument application is terminated and then Windows® exited, the MP1632C menu program starts running, allowing the following menu of functions to be executed:

1. MP1632C Startup
2. Defrag
3. Scandisk
4. Windows Setup
5. MP1632C Startup with Default Settings

These functions are described below.

MP1632C Startup

Select 1 in response to Select Number on the menu, MP1632C application will start after Windows® start.

Defrag

Select 2 in response to Select Number on the menu, the MS-DOS® command Defrag will start running.

The Defrag command rearranges files, recorded on the hard disk in a discontinuous sequence, into a continuous sequence to speed up access to them. Proceed to run Defrag as directed by the screen guidance.

Note

After many cycles of writing to and reading from the hard disk, the data stored on the hard disk would be gradually fragmented, or scattered. Fragmented data takes extra time to access when compared with defragmented data, though the data itself is the same. Defragmenting stored data makes the data faster to access, without such extra time.

Scandisk

Select 3 in response to Select Number on the menu, the MS-DOS® command Scandisk will start running.

The Scandisk command analyzes the status of the disk and correct errors. Proceed to run Scandisk as directed by the screen guidance.

Note

If you continue using a hard disk without correcting defective disk space, it will eventually fill up the free space. Further, applications could fail to run successfully or data might be lost. The Scandisk command restores damaged disk areas by analyzing the disk status.

Windows Setup

Select 4 in response to Select Number on the menu, the MS-DOS® version of the Windows Setup program will start running.

The Windows Setup program displays information on the currently installed hardware and software. It also detects new hardware or software as they are installed, and set them up to make them recognizable to Windows®.

Run this program when setting up the display, keyboard, and mouse. (The Windows® version of the Windows Setup program can be run from the Windows® Main group.) Both versions are similar in function, except the ways they are run.

- Key assignment on the front panel

Although function keys and ESC key are needed for the Windows Setup, there is not those keys on the instrument. To be able to use the Windows Setup without a keyboard, some keys on the front panel is assigned to function keys and ESC key. Following table shows their assignment.

Keyboard	Panel key on the front panel
F1	m/k
F3	n/M
F10	p/G
ESC	Remote

Note

Never run the Windows Setup program to alter settings, unless new peripherals have been connected to the instrument, requiring setup changes. See Chapter 3 for how to connect peripherals to the instrument.

MP1632C Startup with Default Settings

Select 5 in response to Select Number on the menu and MP1632C application will start with all setting initialized after Windows® start.

6.13 Setting a Frequency

3.2G internal synthesizer can generate clock pulses within the frequency range of 50 MHz to 3.2 GHz. Let us take a look at how to make the following settings:

- Clock source
- Reference signal
- Frequency

1. Open the 'Setup:Frequency' panel.

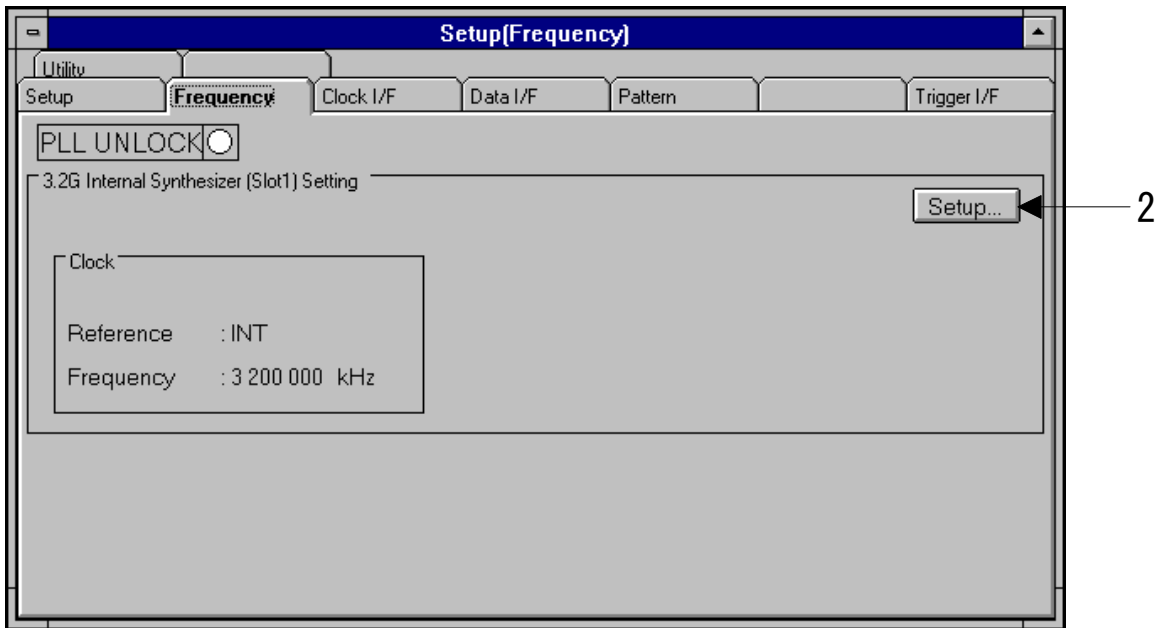

Fig. 6-30 Setup:Frequency Panel

2. Press the Setup button in the 3.2G Internal Synthesizer(Slot1) Setting group box. The 3.2G Internal Synthesizer (Slot1) dialog box will open.

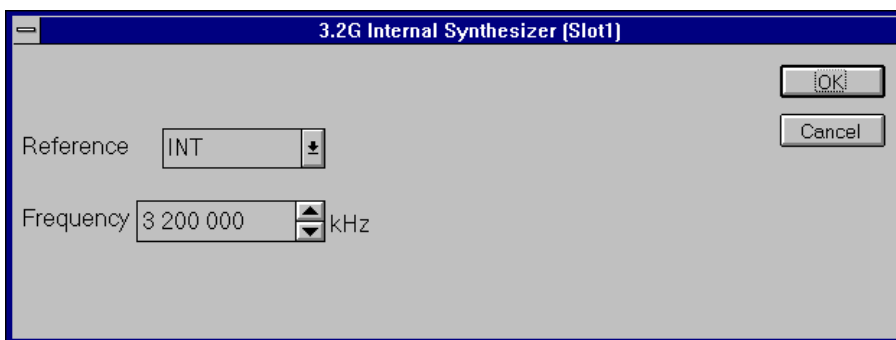

Fig. 6-31 3.2G Internal Synthesizer(Slot1) Dialog Box

3. Set whether an internal or external reference signal is to be used by selecting a reference signal type from the Reference drop-down list box.

INT	Use an internal reference signal.
EXT 10MHz	Use an external reference signal. (10MHz)

4. select a clock frequency from the Frequency spin box.

50 000kHz to 3 200 000kHz (in 1kHz steps)

5. This completes the frequency setting. Press the OK button to make the new setting effective.

6.14 Monitoring the System Error

3.2G internal synthesizer monitors the PLL Unlock alarm. This alarm indicates that the PLL loop has been unlocked.

When this alarm occurs, indication LED on the 'Setup:Frequency' panel lights.

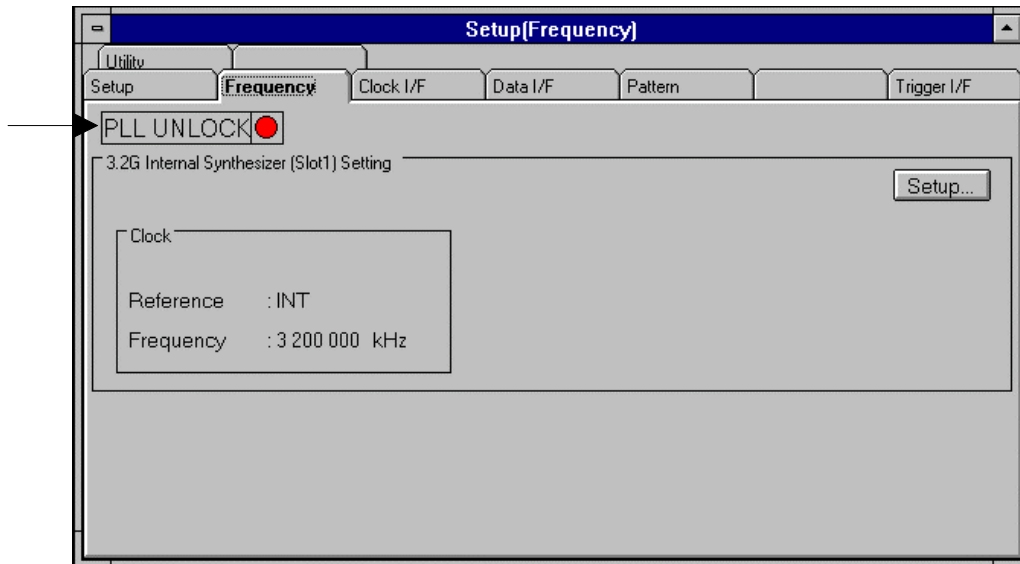

Fig. 6-32 Setup:Frequency Panel

6.15 For the Users of the Existing BERTS

6.15.1 Customize Subwindow

The Customize subwindow is a setup screen that adopts the 1-key/1-parameter operation method of the existing BERTS, allowing you to monitor the measurement result by inputting measurement parameters directly. The screen consists of a total of eight frames: six Setup frames, a Result frame, and a Pattern Edit frame. The user can freely assign setting items to these frames, so only one screen is required to perform all operations necessary to carry out measurements. For example, using the Customize subwindow allows you to measure an error rate with the clock frequency changed continuously.

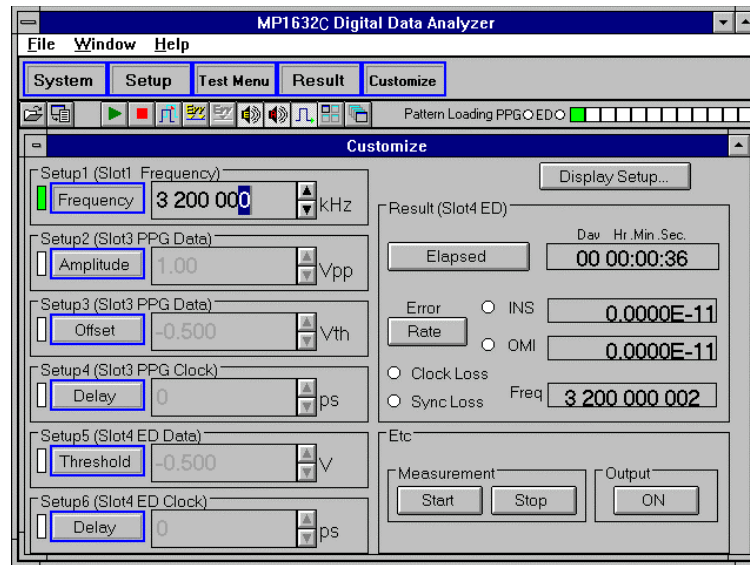

Fig. 6-33 Customize Subwindow

To change a setting, press the button in the associated frame. The LED on the left of the button will light to indicate that setting is enabled. When the button is pressed again, the LED goes off to indicate that setting is disabled. Of all frames of the Customize subwindow, only one frame can be used at a time to make settings. Table 6-1 lists the setting items that can be assigned to the six Setup frames of the Customize subwindow.

Table 6-1 Setup Setting items that can be assigned to Setup frames

Setting items related to 3.2G internal synthesizer	
Frequency	
Setting items related to PPG/ED	
Clock output/input interface	Amplitude, Offset, Delay, Duty, Polarity
Data output/input interface	Amplitude, Offset, Threshold, Cross Point
Pattern	Mark Ratio, Logic, Pattern
Error/Alarm Measurement	Error Type, MEAS. Mode, MEAS. Time

For details on the settings related to the PPG/ED, refer to the "MU163220C 3.2G Pulse Pattern Generator and MU163240C 3.2G Error Detector Operating Manual."

6.15.2 Assigning setting items to Setup frames

This section describes the procedures for assigning setting items to Setup frames. A maximum of six items can be assigned.

1. Press the Display Setup button in the Customize subwindow.

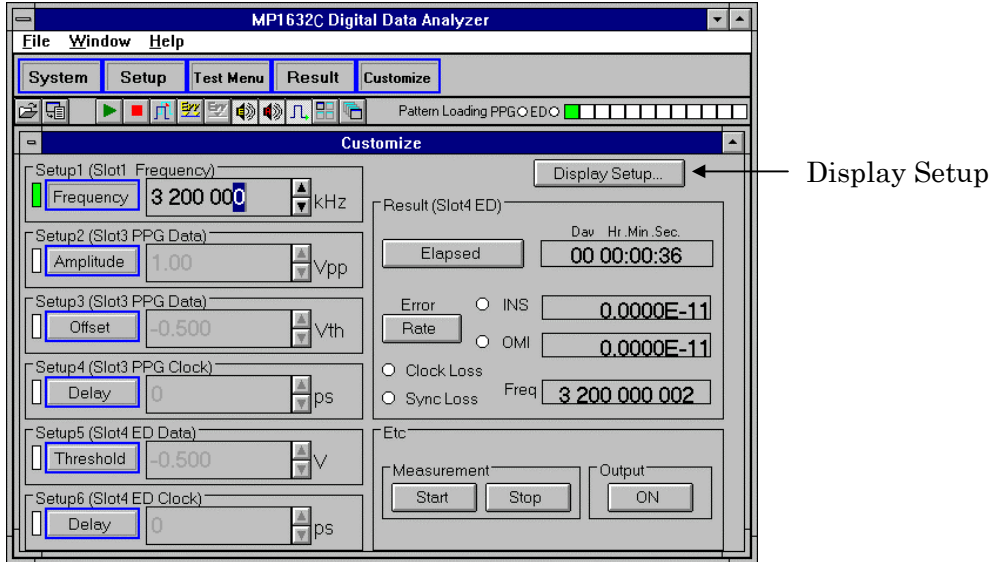

Fig. 6-34 Display Setup button in Customize Subwindow

The Customize Window Display Setup dialog box will open.

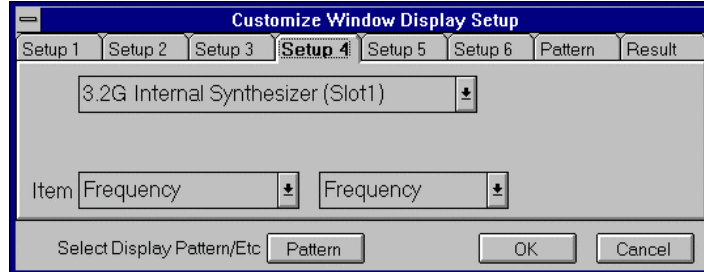

Fig. 6-35 Display Setup Dialog Box

2. Select a frame to which a setting item is to be assigned. Press a tab (Setup1 to Setup6) to open a desired panel.
3. When multiple units are used in combination, select the target unit from the Unit drop-down list box. When it is not necessary to assign any setting item, select OFF.

Note

For the setting item assignment procedure to be followed when a unit other than the "3.2G Internal Synthesizer(Slot1)" is selected, refer to the operation manual that comes with the selected unit.

4. Select a setting item from the Item drop-down list box (1). For the selectable setting items. Here, you can select only Frequency.
5. After selecting the setting item, press the OK button.

CHAPTER 7 PERFORMANCE TEST

7.1 Clock Output

This section describes the procedures for checking the main function of the 3.2G Internal Synthesizer option. Some equipment in below figures is required for this performance test.

7.1.1 Internal clock output

1. To test waveform and frequency of the internal clock output signal, connect equipment as Fig.7-1.

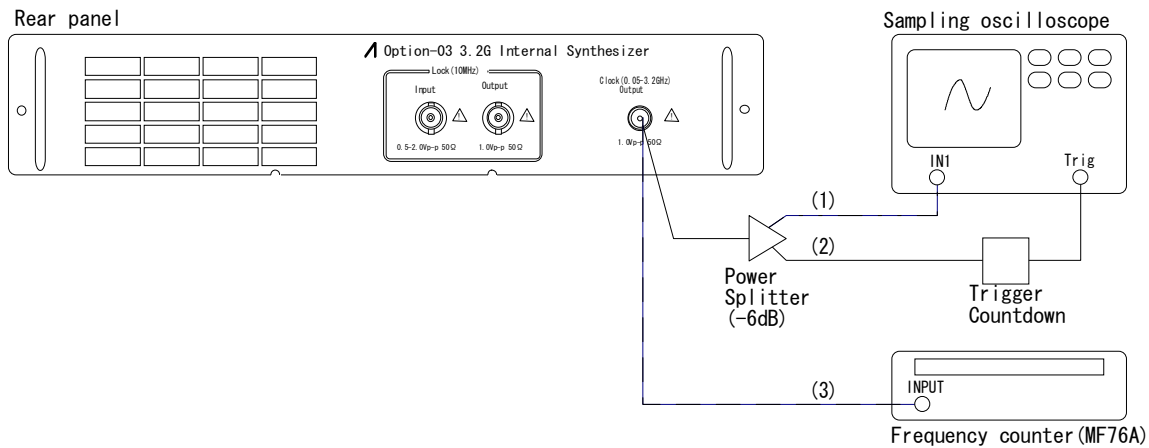

- (1) Connect the Clock Output to the signal input of a sampling oscilloscope through a power splitter(-6dB).
- (2) Connect the Clock Output to the trigger input of a sampling oscilloscope through a power splitter(-6dB) and a trigger countdown.
- (3) Connect the Clock Output to the input of a frequency counter (MF76A).

Fig. 7-1 Connection for the internal clock output test

CAUTION

Use proper attenuators to input level of the oscilloscope and frequency counter you use. There is a risk of damage to equipment.

2. Make settings on the 'Setup:Frequency' panel as following.
 - Reference drop-down list box : Select "INT"
 - Frequency drop-down list box : Input "3 200 000 kHz"
3. Confirm that the frequency value measured by the frequency counter ranges $3.2\text{GHz} \pm 6400\text{Hz}$.

4. Confirm that the amplitude of the waveform measured by the sampling oscilloscope is in the range according to Fig.7-2.

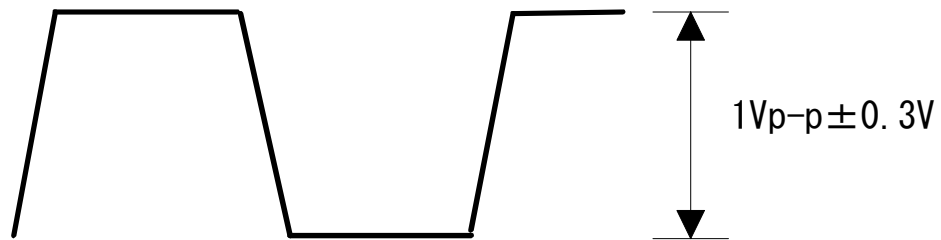

Fig. 7-2 Specification of the clock output signal waveform

5. Change Frequency on the 'Setup:Frequency' to "1 600 001 kHz" and "50 000kHz", and test in the same way as procedure 3 and 4. The specification at each frequency is shown below.

Frequency "1 600 001kHz" : 1,600,001kHz ± 3,200.002Hz

Frequency "50 000kHz" : 50,000kHz ± 100Hz

(Blank)

CHAPTER 8 MAINTENANCE - SCRAPPING

8.1 Daily Care

- To remove surface smears from the instrument, wipe with a cloth moistened with a weak neutral detergent solution.
- If dirt or dust collects on the instrument, suck with a vacuum cleaner.
- Clean head of floppy disk drive with 3.5 inch head cleaning disk set regularly.
- If parts, such as screws, get loose, retighten them using a specified tool.

8.2 Storage Notes

Pay attention of following points when storing the instrument for long time.

1. Remove surface dirt, smears, and other foreign before storing the instrument.
2. Avoid storing the instrument at +60°C or higher or -20°C or lower, or at relative humidities of 85% or higher.
3. Avoid storing the instrument in places that are exposed to direct sunlight or that are dusty.
4. Avoid storing the instrument in places where drops of water may collect on it or it may be affected by active gases.
5. Avoid storing the instrument in places that are liable to oxidation or subject to violent vibration.

- Recommended long-term storage conditions

The instrument should be stored over a long period of time in an environment meeting the following conditions, as well as those suggested above:

1. Temperature: 5°C to 30°C
2. Relative humidity: 40% to 75%
3. Little temperature and humidity change per day

8.3 Shipping

When shipping the instrument, package it in the packing materials in which it had been delivered if they are still retained; if not, follow the packaging steps below. In handling the instrument, wear clean gloves and handle it gently with care not scratch or dent it.

1. Clean the exterior surfaces of the instrument with a dry cloth to remove smears and dirt.
2. Check for loose screws or screws out of position.
3. Safeguard the structural projections or those parts that may get easily deformed, and wrap the instrument in polyethylene sheets, and then package in moisture-proof paper.
4. Put the packaged instrument in a corrugated fiberboard box, sealing the seams with adhesive tapes. Finally, house the package in a skidded wooden box to suit the shipping distance, means and other relevant conditions.
5. In shipping, keep the instrument in an environment that meets the conditions suggested in Section 8.2, "Storage Notes".

8.4 Calibration

The instrument can be calibrated only by the manufacturer and nobody else. Periodic calibration is recommended to sustain satisfactory performance.

8.5 Scrapping

The instrument contains a lithium battery. Its scrapping must conform to the requirements of the governing national and local regulations.

(Blank)

APPENDIXES

Appendix A Display-specific Setup Items

Panel	Group box	Setup item	Default
System:System		Remote	RS-232C(COM1)
		System Mode	Normal Mode
	RS-232C(COM1)	Speed	9600
		Parity	None
		Data Bit Length	8bits
		Stop Bit Length	1bit
		Flow Control	None
	GPIB	GPIB Address	1
	Buzzer:System Error		ON
	Buzzer:Measurement	Error	ON
Alarm		ON	
Setup:Frequency	3.2G Internal Synthesizer Setting:Clock	Reference	INT
		Frequency	3200000

Appendix B Troubleshooting

■ Following error message is appeared at the power on.

“Error found in back-up data. All settings and measured data cleared to default.”

If the above error message is appeared after power on again, the internal-memory back up battery life is ended. Please, call your nearest Anritsu sales office or the representative to replace the battery with a new one by our service department.

Note: The battery life of this instrument is 7 years after delivery. Early replacement is recommended.

The instrument is loaded with the Microsoft® MS-DOS® Operating System and Microsoft® Windows® Operating System, so you can run applications or make Windows® setup changes the same way as you run Windows® on a personal computer.

This appendix lists problems that may result from Windows® setup changes and the suggested remedies.

■ The touch screen does not work

The touch screen would be disabled if you alter the mouse driver setting with the Windows Setup program. Set the mouse to TTwin v3.20:AR5000 and Digitouch with the Windows Setup program and restart Windows®. The touch panel will become operable after Windows® has been restarted.

■ The front-panel LCD display is off

The front-panel LCD would be turned off if you select ChipsCPL from Windows® Control Panel, start the display Driver Control Panel program, and then select CRT in the Display group box.

If an external display is connected to the instrument, select Both in the Display group box while observing the external display. The LCD display will be turned on. If an external display is not connected to the instrument, turn off the power, but not before checking to see that the hard disk access lamp is off. The LCD display will be restored when the instrument is turned on subsequently.

■ The external display is off

The external display would be turned off if you select ChipsCPL from Windows® Control Panel, start the display Driver Control Panel program, and then select LCD in the Display group box.

Select Both in the Display group box while observing the front-panel LCD. The external display will be restored.

■ Application characters are not displayed correctly

Application characters would not be displayed correctly if you delete the font of characters used by the instrument application by running the Fonts program from Windows® Control Panel.

Reinstall the font deleted by running the Fonts program again.

■ **Message asking for Windows® disk insertion appears**

When you are setting printers with the Windows® Control Panel, message like "Insert Microsoft Windows 3.1 Disk #5" may appear. In such a case, insert the correspond recovery FD. The correspondence between number in the message and number labeled recovery FD, is shown below.

Number in the message	1	2		5	6
Number labeled recovery FD	5	6		9	10

Appendix C Entry Table of Performance Test Result

Instrument Name : Option-03 3.2G internal synthesizer
Serial No. : _____
Ambient Temperature : _____ °C
Ambient Humidity : _____ %

● Internal Clock output

Frequency [Hz]	Standard [Hz]	Result
3,200,000,000	$3,200,000,000 \pm 6400$	
1,600,001,000	$1,600,001,000 \pm 3200.002$	
50,000,000	$50,000,000 \pm 100$	

(Blank)